

PRODUCT CATALOGUE

HYDROSTATIC PROBES

SCREW-IN TRANSMITTER





PRESSURE AT THE HIGHEST LEVEL

„Successful medium-sized companies are not successful because they are active in many areas, but rather because they concentrate on one area and do it better than anyone else“

This is our philosophy. That's why BDESENSORS has concentrated on electronic pressure measurement technology from the beginning.

With our unremitting product and quality strategy we have been successful in becoming a major player on the world market for electronic pressure sensing devices within a few years.

With 260 employees at 4 locations in Germany, the Czech Republic, Russia and China BD|SENSORS has solutions from 0.1 mbar to 6000 bar:

- pressure sensors, pressure transducers
pressure transmitters

- electronic pressure switches

- pressure measuring devices with display and
switching outputs

- hydrostatic level probes

Two pressure transmitters and a submersible probe, based on a stainless steel silicon sensor were the beginning. Today the range extends to more than 70 standard products, from economical OEM devices to high-end products with HART® communication or field bus interface.

In addition we have developed hundreds of customer-specific applications, underlining the competence and flexibility of BD|SENSORS. The excellent price/performance ratio of our products is proof of the fact that we are able to meet the toughest demand: Being a problem-solver for our customers.

For large production batches as well as for small production numbers, no matter for what medium or external factors, with almost any mechanical or electrical connection - we solve your problem

flexibly, quickly and cost-efficiently.

INDEX

PROBES	5-72
PRECISION: STAINLESS STEEL PROBES	
stainless steel sensor	5-8
ceramic sensor	9-20
INDUSTRY: STAINLESS STEEL PROBES	
stainless steel sensor	21-36
ceramic sensor	37-56
INDUSTRY: PLASTIC PROBES	
stainless steel sensor	57-60
ceramic sensor	61-72
SCREW-IN TRANSMITTER	73-84
stainless steel sensor	73-76
ceramic sensor	77-84
SPECIAL VERSIONS	85-88
ACCESSORIES	89-97
4 ARGUMENTS	98

	housing material			ø [mm]	stainless steel sensor	ceramic sensor	pressure range / level [mH ₂ O]	preferred areas of use				cable-sensor		certificates	page	
	stainless steel	plastic	CuNiFe					water	sewage	fuel and oil	aggressive media	not separable	separable			
precision																
LMP 308i	•			35	•		0 ... 4 up to 0 ... 200						•		EX	5-8
LMK 382H	•			39.5	•		0 ... 0.6 up to 0 ... 100						•		EX, HART®	9-12
LMK 458H	•		•	39.5	•		0 ... 0.6 up to 0 ... 200						•		EX, HART®, DNV, GL, CCS	13-16
LMK 358H	•			39.5		•	0 ... 0.6 up to 0 ... 100							•	EX, HART®	17-20
industry																
LMP 305	•			19	•		0 ... 1 up to 0 ... 250						•			21-24
LMP 307	•			27	•		0 ... 1 up to 0 ... 250						•		EX, SIL	25-28
LMP 307T	•			27	•		0 ... 1 up to 0 ... 250						•			29-32
LMP 308	•			35	•		0 ... 1 up to 0 ... 250							•	EX, SIL	33-36
LMK 306	•			17		•	0 ... 6 up to 0 ... 200						•			37-40
LMK 307	•			27		•	0 ... 4 up to 0 ... 250						•		EX, SIL	41-44
LMK 382	•			39.5		•	0 ... 0.4 up to 0 ... 100						•		EX	45-48
LMK 458	•		•	39.5		•	0 ... 0.4 up to 0 ... 200						•		EX, DNV, GL, CCS	49-52
LMK 358	•			39.5		•	0 ... 0.4 up to 0 ... 100							•	EX	53-56
LMP 808		•		35	•		0 ... 1 up to 0 ... 100							•	SIL	57-60
LMK 807		•		35		•	0 ... 4 up to 0 ... 100						•		SIL	61-64
LMK 809		•		45		•	0 ... 0.4 up to 0 ... 100						•			65-68
LMK 858		•		45		•	0 ... 0.4 up to 0 ... 100							•		69-72
screw-in transmitter																
LMP 331	•					•	0 ... 1 up to 0 ... 400								EX, SIL	73-76
LMK 331	•	•				•	0 ... 4 up to 0 ... 600								EX, SIL	77-80
LMK 351	•	•				•	0 ... 0.4 up to 0 ... 200								EX	81-84
special versions																
EP 500		•				•	0 ... 60 mbar up to 0 ... 20 bar								GL, CCS	85-88

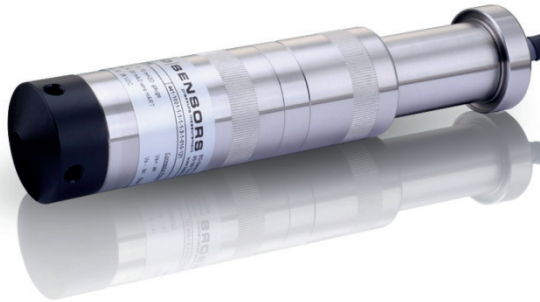

LMP 308i

Separable Stainless Steel Probe Precision

Stainless Steel Sensor

accuracy according to IEC 60770: 0.1 % FSO

Nominal pressure

from 0 ... 4 mH₂O up to 0 ... 200 mH₂O

Output signals

2-wire: 4 ... 20 mA

3-wire: 0 ... 10 V

others on request

Special characteristics

- ▶ diameter 35 mm
- ▶ cable and sensor section separable
- ▶ excellent accuracy
- ▶ communication connection
- ▶ thermal error in compensated range
-20 ... 70 °C: 0.2 % FSO
TC 0.02 % FSO / 10K

Optional versions

- ▶ IS-version zone 0
- ▶ cable protection via corrugated pipe
- ▶ mounting accessories as cable gland and terminal clamp in stainless steel
- ▶ different kinds of cables
- ▶ different kinds of seal materials

The separable precision stainless steel probe LMP 308i is designed for continuous fill level and level measurement of water and liquid mediums. The signal processing of sensor signal is done by digital electronics with 16-bit analog digital converter. Consequently it is possible to conduct an active compensation of sensor intrinsic deviations from normal conditions like nonlinearity and thermal error.

In order to facilitate stock-keeping and maintenance the transmitter body is plugged to the cable assembly with a connector and can be changed easily.

Preferred areas of use are

Water / filtrated Sewage

ground water level measurement



level measurement in wells and open waters / rain spillway basin

level measurement in container

water treatment plants

water recycling



Input pressure range ¹							
Nominal pressure gauge	[bar]	0.40	1	2	4	10	20
Level	[mH ₂ O]	4	10	20	40	100	200
Overpressure	[bar]	2	5	10	20	40	80
Burst pressure	[bar]	3	7.5	15	25	50	120
¹ On customer request we adjust the device within the turn-down-possibility by software on the required pressure range.							
Output signal / Supply							
Standard	2-wire: 4 ... 20 mA / V _S = 12 ... 36 V _{DC} with RS-232 communication interface						
Option IS-protection	2-wire: 4 ... 20 mA / V _S = 14 ... 28 V _{DC}						
Options	3-wire: 0 ... 10 V / V _S = 14 ... 36 V _{DC}						
Performance							
Accuracy	IEC 60770 ² : ≤ ± 0.1 % FSO						
Performance after turn-down (TD)	no change of accuracy ³ formula for accuracy calculating (for nominal pressure gauge ≤ 0.40 bar see note 3): ≤ ± [0.1 + 0.015 x turn-down] % FSO with turn-down = nominal pressure range / adjusted range e.g. following accuracy can be calculated for turn-down 1:10: ≤ ± (0.1 + 0.015 x 10) % FSO viz. the accuracy is ≤ ± 0.25 % FSO						
- TD ≤ 1:5							
- TD > 1:5							
Permissible load	current 2-wire: R _{max} = [(V _S - V _{S min}) / 0.02 A] Ω voltage 3-wire: R _{min} = 10 kΩ						
Influence effects	supply: 0.05 % FSO / 10 V load: 0.05 % FSO / kΩ						
Long term stability	≤ ± (0.1 x turn-down) % FSO / year						
Response time	ca. 200 msec						
Adjustability	following parameters can be adjusted (interface / software needed ⁴) electronic damping: 0 ... 100 sec offset: 0 ... 90 % FSO turn-down of span: max. 1:10						
² accuracy according to IEC 60770 – limit point adjustment (non-linearity, hysteresis, repeatability)							
³ nominal pressure gauges ≤ 0,40 bar are excluded; for these the calculation of accuracy is as follows: ≤ ± (0.1 + 0.02 x turn-down) % FSO e.g. turn-down 1:3: ≤ ± (0.1 + 0.02 x 3) % FSO viz. the accuracy is ≤ ± 0.16 % FSO							
⁴ software, interface and cable must separate be ordered (software is compatible with Windows [®] 95, 98, 2000, NT from version 4.0 or higher and XP)							
Thermal effects (Offset and Span)							
Tolerance band	[% FSO]	≤ ± (0.2 x turn-down)		in compensated range -20 ... 70 °C			
TC	[% FSO / 10 K]	± (0.2 x turn-down)		in compensated range -20 ... 70 °C			
Permissible temperatures	medium: -20 ... 70 °C storage: -25 ... 70 °C electronics / environment: -25 ... 65 °C						
Electrical protection ⁵							
Short-circuit protection	permanent						
Reverse polarity protection	no damage, but also no function						
Electromagnetic compatibility	emission and immunity according to EN 61326						
⁵ additional external overvoltage protection unit in terminal box KL 1 or KL 2 with atmospheric pressure reference available on request							
Electrical connection							
Cable with sheath material ⁶	PVC (-5 ... 70 °C) grey PUR (-20 ... 70 °C) black FEP (-20 ... 70 °C) black others on request						
⁶ cable with integrated air tube for atmospheric pressure reference							
Materials (media wetted)							
Housing	stainless steel 1.4404 (316L)						
Seals	FKM, EPDM, others on request						
Diaphragm	stainless steel 1.4435 (316L)						
Protection cap	POM						
Explosion protection (only for 4 ... 20 mA / 2-wire)							
Approvals	IBExU 10 ATEX 1068 X / IECEx IBE 12.0027X						
DX19-LMP 308 i	zone 0: II 1G Ex ia IIC T4 Ga zone 20: II 1D Ex ia IIIC T 85°C Da						
Safety technical maximum values	U _i = 28 V, I _i = 93 mA, P _i = 660 mW, C _i ≈ 0 nF, L _i ≈ 0 μH, the supply connections have an inner capacity of max. 27 nF to the housing						
Permissible media temperature	in zone 0: -20 ... 60 °C with p _{atm} 0.8 bar up to 1.1 bar in zone 1 or higher: -20 ... 70 °C						
Connecting cables (by factory)	cable capacitance: signal line/shield also signal line/signal line: 160 pF/m cable inductance: signal line/shield also signal line/signal line: 1 μH/m						
Miscellaneous							
Current consumption	signal output current: max. 25 mA						
Weight	approx. 250 g (without cable)						
Ingress protection	IP 68						
CE-conformity	EMC Directive: 2004/108/EC						
ATEX Directive	94/4/EG						

Wiring diagram / connector

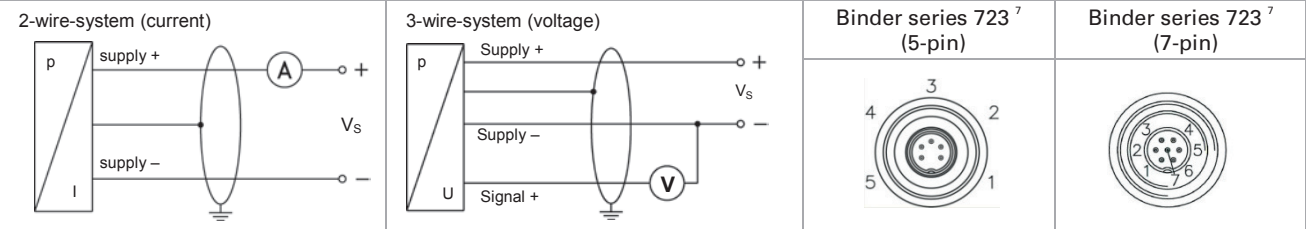

Pin configuration

Electrical connection	Binder series 723 ⁷ (5-pin) / 2-wire	Binder series 723 ⁷ (5-pin) / 3-wire	Binder series 723 ⁷ (7-pin) / 2-wire with communication interface	cable colours (DIN 47100)
Supply +	3	3	3	wh (white)
Supply -	1	4	1	bn (brown)
Signal + (for 3-wire)	-	1	(6)	gn (green)
RxD	-	-	4	-
TxD	-	-	5	-
GND	-	-	7	-
Shield	5	5	2	gn/ye (green / yellow)

⁷ in separated version

Dimensions (in mm)

standard

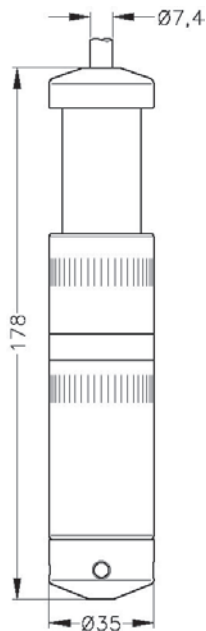

separated version

option

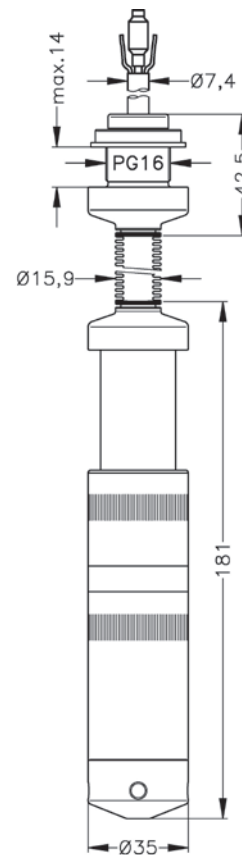

version with
corrugated pipe



LMK 382H

Stainless Steel Probe with HART®-communication

Ceramic Sensor

accuracy according to IEC 60770:
0.1 % FSO

Nominal pressure

from 0 ... 60 cmH₂O up to 0 ... 200 mH₂O

Output signals

2-wire: 4 ... 20 mA
others on request

Special characteristics

- ▶ diameter 39.5 mm
- ▶ HART® communication (setting of offset, span and damping)
- ▶ permissible temperatures up to 85 °C
- ▶ high overpressure resistance
- ▶ high long-term stability

Optional versions

- ▶ IS-version zone 0
- ▶ mounting with stainless steel pipe
- ▶ flange version
- ▶ diaphragm 99.9 % Al₂O₃
- ▶ accessories e.g. assembling and probe flange, mounting clamp

The stainless steel probe LMK 382H has been designed for continuous level measurement in waste water, waste and higher viscosity mediums.

Basic element is a robust and high overpressure capable capacitive ceramic sensor e.g. for low levels.

Preferred areas of use are

 Water
ground water level measurement
rain spillway basin

 Sewage
waste water treatment
water recycling

 Fuel / Oil
level monitoring in open tanks
with low filling heights
fuel storage
tank farms
biogas plants



Pressure ranges ¹									
Nominal pressure	[bar]	0.06	0.16	0.4	1	2	5	10	20
Level	[mH ₂ O]	0.6	1.6	4	10	20	50	100	200
Overpressure	[bar]	2	4	6	8	15	25	35	45

¹ On customer request we adjust the devices by software on the required pressure ranges, within the turn-down possibility (starting at 0.02 bar).

Output signal / Supply	
Standard	2-wire: 4 ... 20 mA / V _S = 12 ... 36 V _{DC} with HART [®] communication V _{S rated} = 24 V _{DC}
Option IS- protection	2-wire: 4 ... 20 mA / V _S = 14 ... 28 V _{DC} with HART [®] communication V _{S rated} = 24 V _{DC}
Performance	
Accuracy ²	P _N ≥ 160 mbar TD ≤ 1:5 ≤ ± 0.2 % FSO TD > 1:5 ≤ ± [0.2 + 0.03 x TD] % FSO TD _{max} = 1:10
	P _N < 160 mbar ≤ ± [0.2 + 0.1 x TD] % FSO TD _{max} = 1:3
	P _N ≥ 1 bar TD ≤ 1:5 ≤ ± 0.1 % FSO TD > 1:5 ≤ ± [0.1 + 0.02 x TD] % FSO TD _{max} = 1:10
Permissible load	R _{max} = [(V _S - V _{S min}) / 0.02 A] Ω load at HART [®] -communication: R _{min} = 250 Ω
Long term stability	≤ ± (0.1 x turn-down) % FSO / year at reference conditions
Influence effects	supply: 0.05 % FSO / 10 V permissible load: 0.05 % FSO / kΩ
Turn-on time	850 msec
Mean response time	140 msec without consideration of electronic damping mean measuring rate 7/sec
Max. response time	380 msec
Adjustability	configuration of following parameters possible (interface / software necessary ³): - electronic damping: 0 ... 100 sec - offset: 0 ... 80 % FSO - turn down of span: max. 1:10

² accuracy according to IEC 60770 – limit point adjustment (non-linearity, hysteresis, repeatability)

³ software, interface, and cable have to be ordered separately (software appropriate for Windows[®] 95, 98, 2000, NT Version 4.0 or higher, and XP)

Thermal effects (Offset and Span)	
Tolerance band	≤ ± (0.2 x turn-down) % FSO
TC, average	± (0.02 x turn-down) % FSO / 10 K
in compensated range	-20 ... 80 °C
Permissible temperatures	medium: -25 ... 85 °C electronics / environment: -25 ... 85 °C storage: -25 ... 85 °C

Electrical protection ⁴	
Short-circuit protection	permanent
Reverse polarity protection	no damage, but also no function
Electromagnetic compatibility	emission and immunity according to EN 61326

⁴ additional external overvoltage protection unit in terminal box KL 1 or KL 2 with atmospheric pressure reference available on request

Mechanical stability	
Vibration	4 g (according to: DIN EN 60068-2-6)

Electrical connection	
Cable outlet with sheat material ⁵	PVC (-5 ... 70 °C) grey PUR (-25 ... 70 °C) black FEP (-25 ... 70 °C) black TPE (-25 ... 85 °C) blue

⁵ shielded cable with integrated air tube for atmospheric pressure reference

Materials	
Housing	stainless steel 1.4404
Seals	FKM FFKM EPDM others on request
Diaphragm	standard: ceramics Al ₂ O ₃ 96 % option: ceramics Al ₂ O ₃ 99.9 %
Protection cap	POM

Miscellaneous	
Option cable protection	stainless steel pipe for probe in stainless steel: available as compact product (standard: stainless steel pipe with a total length up to 2 m possible; other lengths on request)
Ingress protection	IP 68
Current consumption	max. 21 mA
Weight	approx. 400 g (without cable)
CE-conformity	EMC Directive: 2004/108/EC

IS-protection	
Approval DX15A-LMK 382H	IBExU 10 ATEX 1186 X zone 0 ⁶ : II 1G Ex ia IIB T4 zone 20: II 1D Ex iaD 20 T85°C
Safety technical maximum values	$U_i = 28 \text{ V}$, $I_i = 93 \text{ mA}$, $P_i = 660 \text{ mW}$, $C_i = 0 \text{ nF}$, $L_i = 0 \text{ }\mu\text{H}$, the supply connections have an inner capacity of max. 27 nF opposite the enclosure
Permissible media temperature	in zone 0: $-10 \dots 60 \text{ }^\circ\text{C}$ with p_{atm} 0.8 bar up to 1.1 bar zone 1 or higher: $-25 \dots 70 \text{ }^\circ\text{C}$
Connecting cables (by factory)	cable capacitance: signal line/shield also signal line/signal line: 160 pF/m cable inductance: signal line/shield also signal line/signal line: 1 $\mu\text{H}/\text{m}$
⁶ for optional stainless steel pipe following designation is valid: "II 1G Ex ia IIC T4" (zone 0)	

Wiring diagram

2-wire-system (current) HART[®]

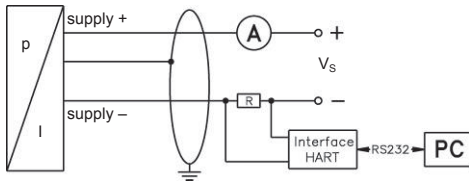

Pin configuration

Electrical connection	cable colours (DIN 47100)
Supply +	wh (white)
Supply -	bn (brown)
Shield	gn/ye (green / yellow)

Dimensions (in mm)

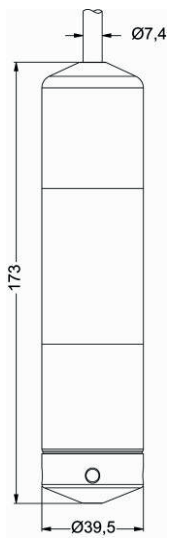

standard

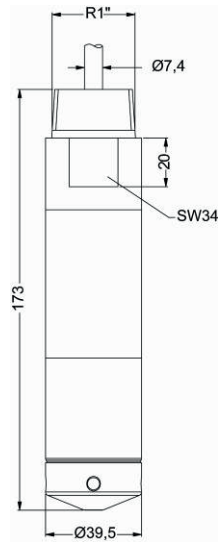

thread R1"
for stainless steel pipe

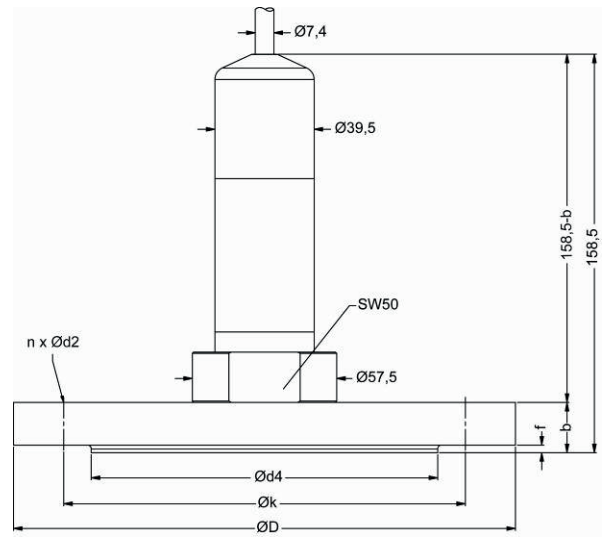

flange version

dimensions in mm				
dimen- sions	DN25 / PN40	DN40/ PN40	DN50 / PN40	DN80 / PN16
D	115	150	165	200
K	85	110	125	160
d4	68	88	102	138
b	18	18	20	20
f	2	3	3	3
n	4	4	4	8
d2	14	18	18	18

HART[®] is a registered trade mark of HART Communication Foundation;
Windows[®] is a registered trade mark of Microsoft Corporation



LMK 458H

Probe
with HART[®]-communication
for Marine and Offshore

Ceramic Sensor

accuracy according to IEC 60770:
0.1 % FSO

Nominal pressure

from 0 ... 60 cmH₂O up to 0 ... 200 mH₂O

Output signals

2-wire: 4 ... 20 mA
others on request

Special characteristics

- ▶ diameter 39.5 mm
- ▶ HART[®] communication (setting of offset, span and damping)
- ▶ high overpressure resistance
- ▶ high long-term stability

Optional versions

- ▶ IS-version Ex ia = intrinsically safe for gases and dusts
- ▶ diaphragm Al₂O₃ 99.9 %
- ▶ different housing materials (stainless steel, CuNiFe)
- ▶ screw-in and flange version
- ▶ accessories e. g. assembling and probe flange, mounting clamp

The hydrostatic probe LMK 458H has been developed for measuring level in service and storage tanks and is as a consequence of the certification by Germanischer Lloyd predestined for shipbuilding and offshore applications.

A permissible operating temperature of up to 85 °C and the possibility to use the device in intrinsic safe areas enable to measure the pressure of various fluids under extreme conditions. The basis for the LMK 458H is a capacitive ceramic sensor element, which offers a high overload resistance and medium compatibility.

Preferred areas of use are



Water

Drinking water abstraction
Desalinization plant

Shipbuilding / Offshore



Ballast tanks
Draught monitoring
Level measurement in ballast and storage tanks



Pressure ranges									
Nominal pressure ¹	[bar]	0.06	0.16	0.4	1	2	5	10	20
Level	[mH ₂ O]	0.6	1.6	4	10	20	50	100	200
Overpressure	[bar]	2	4	6	8	15	25	35	45
¹ On customer request we adjust the devices by software on the required pressure ranges, within the turn-down possibility (starting at 0.02 bar).									
Output signal / Supply									
Standard	2-wire: 4 ... 20 mA / V _S = 12 ... 36 V _{DC} with HART [®] communication V _{S rated} = 24 V _{DC}								
Option IS-version	2-wire: 4 ... 20 mA / V _S = 14 ... 28 V _{DC} with HART [®] communication V _{S rated} = 24 V _{DC}								
Performance									
Accuracy ²	P _N ≥ 160 mbar	TD ≤ 1:5		≤ ± 0.2 % FSO				TD _{max} = 1:10	
	P _N < 160 mbar	TD > 1:5		≤ ± [0.2 + 0.03 x TD] % FSO				TD _{max} = 1:3	
				≤ ± [0.2 + 0.1 x TD] % FSO					
P _N ≥ 1 bar	TD ≤ 1:5		≤ ± 0.1 % FSO				TD _{max} = 1: 10		
	TD > 1:5		≤ ± [0.1 + 0.02 x TD] % FSO						
Permissible load	R _{max} = [(V _S - V _{S min}) / 0.02 A] Ω load at HART [®] -communication: R _{min} = 250 Ω								
Long term stability	≤ ± (0.1 x turn-down) FSO / year at reference conditions								
Influence effects	supply: 0.05 % FSO / 10 V permissible load: 0.05 % FSO / kΩ								
Turn-on time	850 msec								
Mean response time	140 msec without consideration of electronic damping						mean measuring rate 7/sec		
Max. response time	380 msec								
Adjustability	configuration of following parameters possible (interface / software necessary ³): - electronic damping: 0 ... 100 sec - offset: 0 ... 80 % FSO - turn down of span: max. 1:10								
² accuracy according to IEC 60770 – limit point adjustment (non-linearity, hysteresis, repeatability)									
³ software, interface, and cable have to be ordered separately (software appropriate for Windows [®] 95, 98, 2000, NT Version 4.0 or higher, and XP)									
Thermal effects (Offset and Span) / Permissible temperatures									
Tolerance band	≤ ± [0.2 x turn-down] % FSO								
TC, average	≤ ± [0.02 x turn-down] % FSO / 10 K								
in compensated range	-20 ... 80 °C								
Permissible temperatures	medium: -25 ... 85 °C			electronics / environment: -25 ... 85 °C			storage: -25 ... 85 °C		
Electrical protection ⁴									
Short-circuit protection	permanent								
Reverse polarity protection	no damage, but also no function								
Electromagnetic compatibility	emission and immunity according to - EN 61326 - Germanischer Lloyd (GL) - Det Norske Veritas (DNV)								
⁴ additional external overvoltage protection unit in terminal box KL 1 or KL 2 with atmospheric pressure reference available									
Mechanical stability									
Vibration	4 g (according to GL: curve 2 / according to DNV: Class B / basis: DIN EN 60068-2-6)								
Electrical connection									
Cable outlet with sheath material ⁵	PUR	(-25 ... 70 °C)		black					
	FEP	(-25 ... 70 °C)		black					
	TPE	(-25 ... 85 °C)		blue					
	others on request								
⁵ shielded cable with integrated air tube for atmospheric pressure reference									
Materials (media wetted)									
Housing	standard: stainless steel 1.4404 (316L)			option: CuNi10Fe1Mn (resistant against sea water)					
Seals	FKM; FFKM; EPDM others on request								
Diaphragm	standard: ceramics Al ₂ O ₃ 96 %			option: ceramics Al ₂ O ₃ 99.9 %					
Nose cone	POM								
Category of the environment									
Germanischer Lloyd (GL)	D, EMC 1			number of certificate: 19 777 - 11 HH					
Det Norske Veritas (DNV)	temperature: D humidity: B			vibration: B					
	electromagnetic compatibility: B			number of certificate: A-12144					
Miscellaneous									
Cable protection	stainless steel pipe for probe in stainless steel: available as compact product (standard: stainless steel pipe with a total length up to 2 m possible; other lengths on request)								
Ingress protection	IP 68								
Current consumption	max. 21 mA								
Weight	min. 650 g (without cable)								
CE-conformity	EMC Directive: 2004/108/EC								



LMK 358H

Separable Stainless Steel Probe with HART[®]-communication

Ceramic Sensor

accuracy according to IEC 60770:
0.1 % FSO

Nominal pressure

from 0 ... 60 cmH₂O up to 0 ... 100 mH₂O

Output signals

2-wire: 4 ... 20 mA
others on request

Special characteristics

- ▶ diameter 39.5 mm
- ▶ cable and sensor section separable
- ▶ HART[®] communication (setting of offset, span and damping)
- ▶ permissible temperatures up to 85 °C
- ▶ high long-term stability

Optional versions

- ▶ IS-version zone 0
- ▶ cable protection via corrugated pipe
- ▶ diaphragm 99.9 % Al₂O₃

The separable stainless steel probe LMK 358H has been designed for level measurement in waste water, waste and higher viscosity media. Basic element is a capacitive ceramic sensor.

In order to facilitate stock-keeping and maintenance the transmitter head is plugged to the cable assembly with a connector and can be changed easily.

Preferred areas of use are

 Water
ground water level measurement
rain spillway basin

 Sewage
waste water treatment
water recycling

 Fuel / Oil
level monitoring in open tanks
with low filling heights
fuel storage
tank farms
biogas plants



Input pressure range ¹								
Nominal pressure gauge	[bar]	0.06	0.16	0.4	1	2	5	10
Level	[mH ₂ O]	0.6	1.6	4	10	20	50	100
Overpressure	[bar]	2	4	6	8	15	25	35

¹ On customer request we adjust the devices by software on the required pressure ranges, within the turn-down-possibility (starting at 0.02 bar)

Output signal / Supply			
Standard	2-wire: 4 ... 20 mA / V _S = 12 ... 36 V _{DC} with HART [□] communication V _{S rated} = 24 V _{DC}		
Option IS-protection	2-wire: 4 ... 20 mA / V _S = 12 ... 28 V _{DC} with HART [□] communication V _{S rated} = 24 V _{DC}		
Performance			
Accuracy ²	P _N ≥ 160 mbar	TD ≤ 1:5 ≤ ± 0.2 % FSO TD > 1:5 ≤ ± [0.2 + 0.03 x TD] % FSO	TD _{max} = 1:10
	P _N < 160 mbar		TD _{max} = 1:3
	P _N ≥ 1 bar	TD ≤ 1:5 ≤ ± 0.1 % FSO TD > 1:5 ≤ ± [0.1 + 0.02 x TD] % FSO	TD _{max} = 1:10
Permissible load	R _{max} = [(V _S - V _{S min}) / 0.02 A] Ω load at HART [□] -communication: R _{min} = 250 Ω		
Long term stability	≤ ± (0.1 x turn-down) % FSO / year at reference conditions		
Influence effects	supply: 0.05 % FSO / 10 V load: 0.05 % FSO / kΩ		
Turn-on time	850 msec		
Mean response time	140 msec – without consideration of electronic damping	measuring rate 7/sec	
Max. response time	380 msec		
Adjustability	configuration of following parameters possible (interface / software necessary ³) - electronic damping 0 ... 100 sec - offset: 0 ... 80 % FSO - turn-down of span: max. 1:10		

² accuracy according to IEC 60770 – limit point adjustment (non-linearity, hysteresis, repeatability)

³ software, interface, and cable have to be ordered separately (software appropriate for Windows[®] 95, 98, 2000, NT Version 4.0 or higher, and XP)

Thermal effects (Offset and Span) / - permissible temperatures	
Tolerance band	≤ ± (0.2 x turn-down) % FSO
TC, average	± (0.02 x turn-down) % FSO / 10 K
in compensated range	-20 ... 80 °C
Permissible temperatures	medium: -25 ... 85 °C electronic / environment: -25 ... 85 °C storage: -25 ... 85 °C

Electrical protection ⁴	
Short-circuit protection	permanent
Reverse polarity protection	no damage, but also no function
Electromagnetic compatibility	emission and immunity according to EN 61326

⁴ additional external overvoltage protection unit in terminal box KL 1 or KL 2 with atmospheric pressure reference available on request

Mechanical stability	
Vibration	4 g (according to: DIN EN 60068-2-6)

Electrical connection	
Cable with sheath material ⁵	PVC (-5 ... 70 °C) grey PUR (-25 ... 70 °C) black FEP (-25 ... 70 °C) black TPE (-25 ... 85 °C) blue

⁵ shielded cable with integrated air tube for atmospheric pressure reference

Materials (media wetted)	
Housing	stainless steel 1.4404 (316L)
Seals	FKM EPDM others on request
Diaphragm	standard: ceramics Al ₂ O ₃ 96 % option: ceramics Al ₂ O ₃ 99.9 %
Protection cap	POM

Explosion protection	
Approval DX15A-LMK 358H	IBExU 10 ATEX 1186 X Zone 0 ⁶ : II 1G Ex ia IIB T4 zone 20: II 1D Ex iaD 20 T85°C
Safety technical maximum values	U _i = 28 V, I _i = 93 mA, P _i = 660 mW, C _i = 0 nF, L _i = 0 μH, the supply connections have an inner capacity of max. 27 nF opposite the enclosure
Permissible media temperature	in zone 0: -20 ... 60 °C with p _{atm} 0.8 bar up to 1.1 bar zone 1 or higher: -25 ... 70 °C
Connecting cables (by factory)	cable capacitance: signal line/shield also signal line/signal line: 160 pF/m cable inductance: signal line/shield also signal line/signal line: 1 μH/m

⁶ for optional stainless steel pipe following designation is valid: "II 1G Ex ia IIC T4" (zone 0)

Miscellaneous	
Option cable protection	stainless steel pipe for probe in stainless steel: available as compact product (standard: stainless steel pipe with a total length up to 2 m possible; other lengths on request)
Current consumption	max. 21 mA
Weight	approx. 650 g (without cable)
Ingress protection	IP 68
CE-conformity	EMC Directive: 2004/108/EC

Wiring diagram

2-wire-system (current) HART[®]

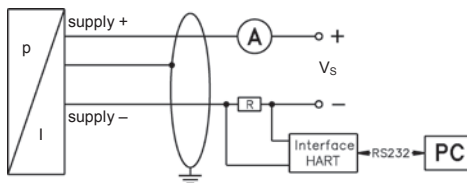

connector



Pin configuration

Electrical connection	Binder series 723 ⁷ (5-pin)	cable colours (DIN 47100)
Supply +	3	wh (white)
Supply -	1	gn (brown)
Shield	5	gn/ye (yellow / green)

⁷ in separated version

Dimensions (in mm)

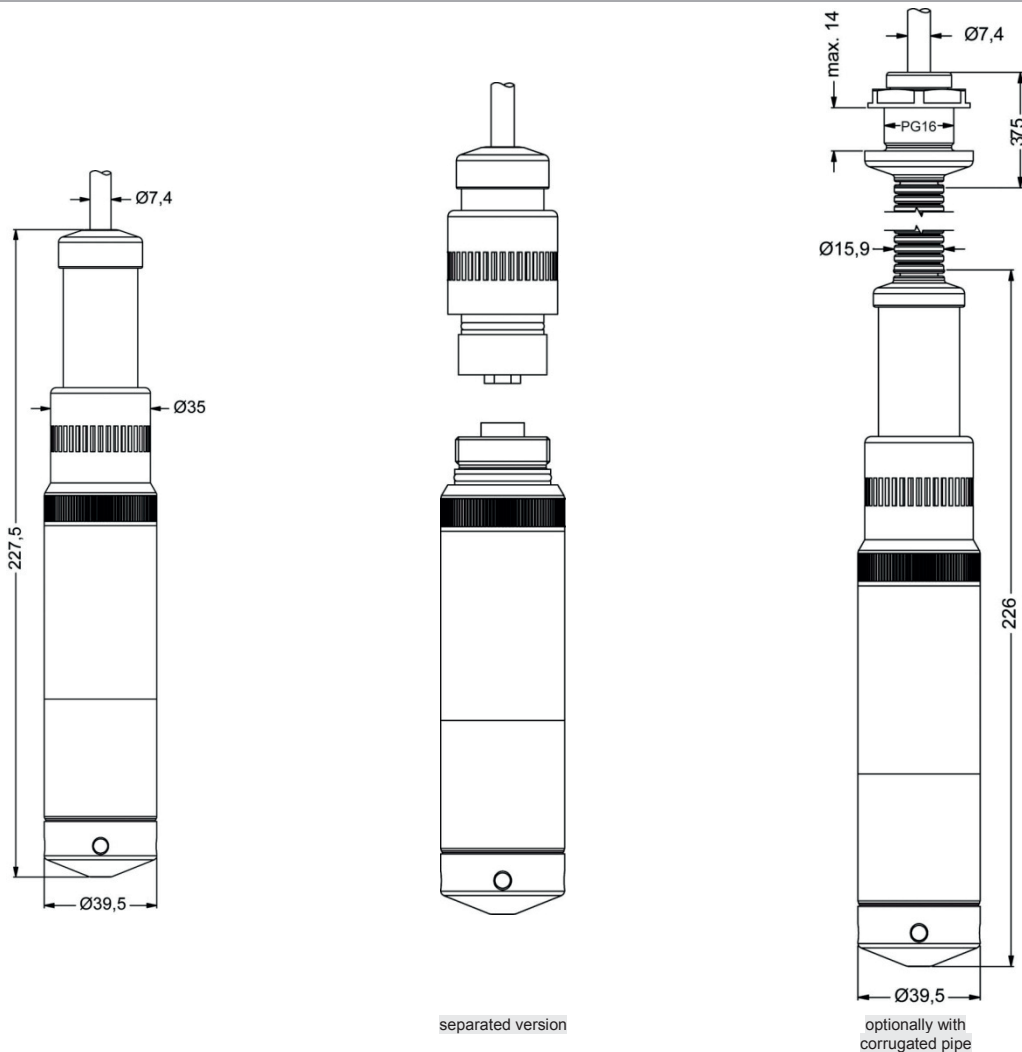



LMP 305

Slimline Probe

Stainless Steel Sensor

accuracy according to IEC 60770:
 standard: 0.35 % FSO
 option: 0.25 % FSO

Nominal pressure

from 0 ... 1 mH₂O up to 0 ... 250 mH₂O

Output signals

2-wire: 4 ... 20 mA
 others on request

Special characteristics

- ▶ diameter 19 mm for cramped areas
- ▶ small thermal effect
- ▶ excellent long term stability
- ▶ excellent linearity

Optional versions

- ▶ different kinds of cable
- ▶ customer specific versions
 e.g. special pressure ranges

The slimline probe LMP 305 with silicon stainless steel sensor is designed for continuous level measurement in confined space conditions. Permissible media are clean or waste water and thin fluids.

A piezoresistiv stainless steel sensor with low thermal error, an excellent linearity and a long term stability, is basis of LMP 305.

Preferred areas of use are

Water

level measurement in confined space conditions



ground water monitoring

depth or level measurement in wells and open waters

drinking water system

level measurement in container



Input pressure range														
Nominal pressure gauge	[bar]	0.1	0.16	0.25	0.4	0.6	1	1.6	2.5	4	6	10	16	25
Level	[mH ₂ O]	1	1.6	2.5	4	6	10	16	25	40	60	100	160	250
Overpressure	[bar]	1	1	1	1	3	3	6	6	20	20	60	60	100

Output signal / Supply	
Standard	2-wire: 4 ... 20 mA / V _S = 12 ... 36 V _{DC}
Performance	
Accuracy	standard: nominal pressure > 0.4 bar: ≤ ± 0.35 % FSO nominal pressure ≤ 0.4 bar: ≤ ± 0.50 % FSO option: nominal pressure > 0.4 bar: ≤ ± 0.25 % FSO
Permissible load	R _{max} = [(V _S - V _{S,min}) / 0,02 A] Ω
Influence effects	supply: 0.05 % FSO / 10 V load: 0.05 % FSO / kΩ
Long term stability	≤ ± 0.1 % FSO / year
Response time	< 10 msec

¹ accuracy according to IEC 60770 – limit point adjustment (non-linearity, hysteresis, repeatability)

Thermal effects (Offset and Span)						
Nominal pressure P _N	[bar]	≤ 0.1	≤ 0.25	≤ 0.4	≤ 1	> 1
Tolerance band	[% FSO]	≤ ± 2	≤ ± 1.5	≤ ± 1	≤ ± 1	≤ ± 0.75
TC, average	[% FSO / 10 K]	± 0.3	± 0.2	± 0.14	± 0.1	± 0.07
in compensated range	[°C]	0 ... 50			0 ... 70	

Permissible temperatures	
Permissible temperatures	medium: -10 ... 70 °C storage: -25 ... 70 °C

Electrical protection ²	
Short-circuit protection	permanent
Reverse polarity protection	no damage, but also no function
Electromagnetic compatibility	emission and immunity according to EN 61326

² additional external overvoltage protection unit in terminal box KL 1 or KL 2 with atmospheric pressure reference available on request

Electrical connection	
Cable with sheath material ³	PVC (-5 ... 70 °C) grey PUR (-10 ... 70 °C) black FEP (-10 ... 70 °C) black others on request

³ cable with integrated air tube for atmospheric pressure reference

Materials (media wetted)	
Housing	stainless steel 1.4404 (316L)
Seals	FKM / EPDM
Diaphragm	stainless steel 1.4435 (316L)
Protection cap	POM
Cable sheath	PVC / PUR / FEP

Miscellaneous	
Connecting cables (by factory)	cable capacitance: signal line/shield also signal line/signal line: 160 pF/m cable inductance: signal line/shield also signal line/signal line: 1 μH/m
Current consumption	signal output current: max. 25 mA
Weight	approx. 100 g (without cable)
Ingress protection	IP 68
CE-conformity	EMC Directive: 2004/108/EC

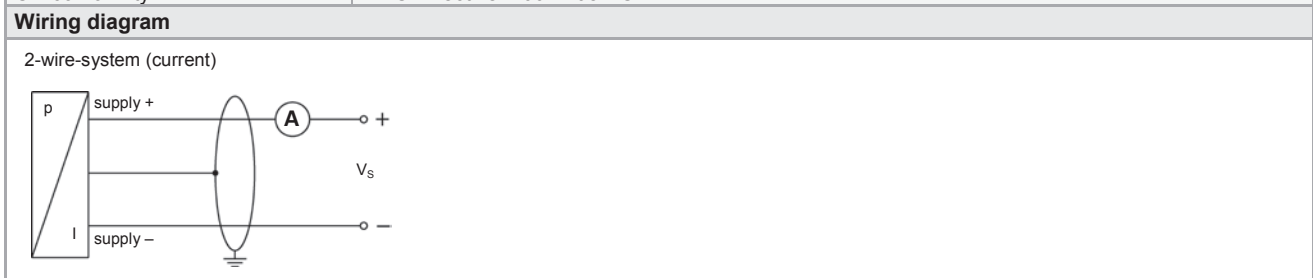

Pin configuration	
Electrical connection	cable colours (DIN 47100)
Supply +	wh (white)
Supply -	bn (brown)
Shield	gn/ye (green / yellow)

Dimensions (in mm)

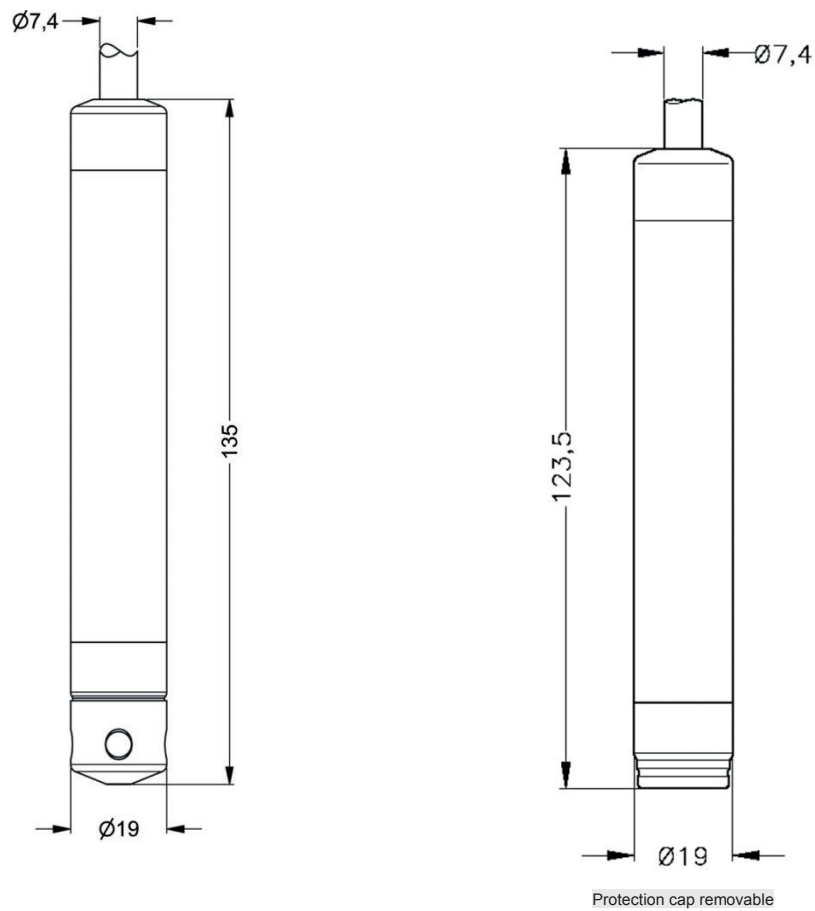



LMP 307

Stainless Steel Probe

Stainless Steel Sensor

accuracy according to IEC 60770:
 standard: 0.35 % FSO
 option: 0.25 % / 0.1 % FSO

Nominal pressure

from 0 ... 1 mH₂O up to 0 ... 250 mH₂O

Output signals

2-wire: 4 ... 20 mA
 3-wire: 0 ... 20 mA / 0 ... 10 V
 others on request

Special characteristics

- ▶ diameter 27 mm
- ▶ small thermal effect
- ▶ excellent accuracy
- ▶ excellent long term stability

Optional versions

- ▶ IS-protection zone 0
- ▶ SIL 2 (Safety Integrity Level)
- ▶ cable protection via corrugated pipe
- ▶ different kinds of cables
- ▶ different kinds of seal materials

The stainless steel probe LMP 307 is designed for continuous level measurement in water and clean or waste fluids.

Basic element is a high quality stainless steel sensor with high requirements for exact measurement with excellent long term stability.

Preferred areas of use are

Water / filtrated sewage

- drinking water system
-  ground water level measurement
- rain spillway basin
- pump and booster stations
- level measurement in container
- water treatment plants
- water recycling

Fuel / Oil

-  fuel storage
- tank farm



Input pressure range														
Nominal pressure gauge	[bar]	0.1	0.16	0.25	0.4	0.6	1	1.6	2.5	4	6	10	16	25
Level	[mH ₂ O]	1	1.6	2.5	4	6	10	16	25	40	60	100	160	250
Overpressure	[bar]	0.5	1	1	2	5	5	10	10	20	40	40	80	80
Burst pressure \geq	[bar]	1.5	1.5	1.5	3	7.5	7.5	15	15	25	50	50	120	120

Output signal / Supply	
Standard	2-wire: 4 ... 20 mA / $V_S = 8 \dots 32 V_{DC}$
Option Ex-protection	2-wire: 4 ... 20 mA / $V_S = 10 \dots 28 V_{DC}$
Options 3-wire	3-wire: 0 ... 20 mA / $V_S = 14 \dots 30 V_{DC}$ 0 ... 10 V / $V_S = 14 \dots 30 V_{DC}$

Performance	
Accuracy	standard: nominal pressure < 0.4 bar: $\leq \pm 0.5\%$ FSO nominal pressure ≥ 0.4 bar: $\leq \pm 0.35\%$ FSO option 1: nominal pressure ≥ 0.4 bar: $\leq \pm 0.25\%$ FSO option 2: for all nominal pressures: $\leq \pm 0.1\%$ FSO
Permissible load	current 2-wire: $R_{max} = [(V_S - V_S \text{ min}) / 0.02 \text{ A}] \Omega$ current 3-wire: $R_{max} = 500 \Omega$ voltage 3-wire: $R_{min} = 10 \text{ k}\Omega$
Influence effects	supply: 0.05 % FSO / 10 V load: 0.05 % FSO / k Ω
Long term stability	$\leq \pm 0.1\%$ FSO / year
Response time	2-wire: ≤ 10 msec; 3-wire: ≤ 3 msec

¹ accuracy according to IEC 60770 – limit point adjustment (non-linearity, hysteresis, repeatability)

Thermal effects (Offset and Span)	
Nominal pressure P_N	[bar] < 0.40 ≥ 0.40
Tolerance band	[% FSO] $\leq \pm 1$ $\leq \pm 0.75$
in compensated range	[°C] 0 ... 70

Permissible temperatures	
Permissible temperatures	medium: -10 ... 70 °C storage: -25 ... 70 °C

Electrical protection ²	
Short-circuit protection	permanent
Reverse polarity protection	no damage, but also no function
Electromagnetic compatibility	emission and immunity according to EN 61326

² additional external overvoltage protection unit in terminal box KL 1 or KL 2 with atmospheric pressure reference available on request

Electrical connection	
Cable with sheath material ³	PVC (-5 ... 70 °C) grey PUR (-10 ... 70 °C) black FEP (-10 ... 70 °C) black

³ cable with integrated air tube for atmospheric pressure reference

Materials (media wetted)	
Housing	stainless steel 1.4404 (316L)
Seals	FKM others on request
Diaphragm	stainless steel 1.4435 (316L)
Protection cap	POM

Explosion protection (only for 4 ... 20 mA / 2-wire)	
Approvals DX19-LMP 307	IBExU 10 ATEX 1068 X / IECEx IBE 12.0027X zone 0: II 1G Ex ia IIC T4 Ga zone 20: II 1D Ex ia IIIC T 85°C Da
Safety technical maximum values	$U_i = 28 \text{ V}$, $I_i = 93 \text{ mA}$, $P_i = 660 \text{ mW}$, $C_i \approx 0 \text{ nF}$, $L_i \approx 0 \mu\text{H}$, the supply connections have an inner capacity of max. 27 nF to the housing
Permissible media temperature	in zone 0: -10 ... 60 °C with p_{atm} 0.8 bar up to 1.1 bar in zone 1 or higher: -10 ... 70 °C
Connecting cables (by factory)	cable capacitance: signal line/shield also signal line/signal line: 160 pF/m cable inductance: signal line/shield also signal line/signal line: 1 $\mu\text{H}/\text{m}$

Miscellaneous	
Option SIL ⁴ 2 application	according to IEC 61508 / IEC 61511
Current consumption	signal output current: max. 25 mA / signal output voltage: max. 7 mA
Weight	approx. 200 g (without cable)
Ingress protection	IP 68
CE-conformity	EMC Directive: 2004/108/EC
ATEX Directive	94/4/EG

⁴ not in combination with the accuracy 0.1%, only for 4...20mA / 2-wire

Wiring diagrams

2-wire-system (current)

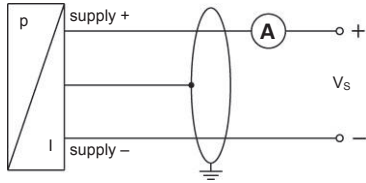

3-wire-system (current / voltage)

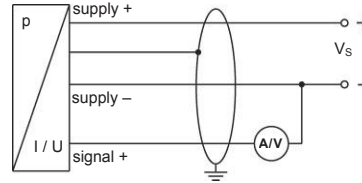

Pin configuration

Electrical connection	cable colours (DIN 47100)
Supply +	wh (white)
Supply -	bn (brown)
Signal + (only 3-wire)	gn (green)
Shield	ye/gn (yellow / green)

Dimensions (in mm)

standard

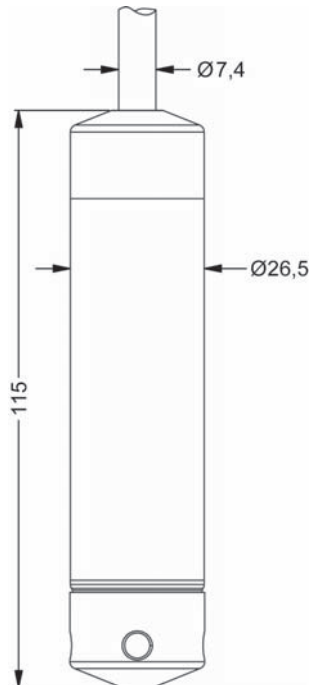

option

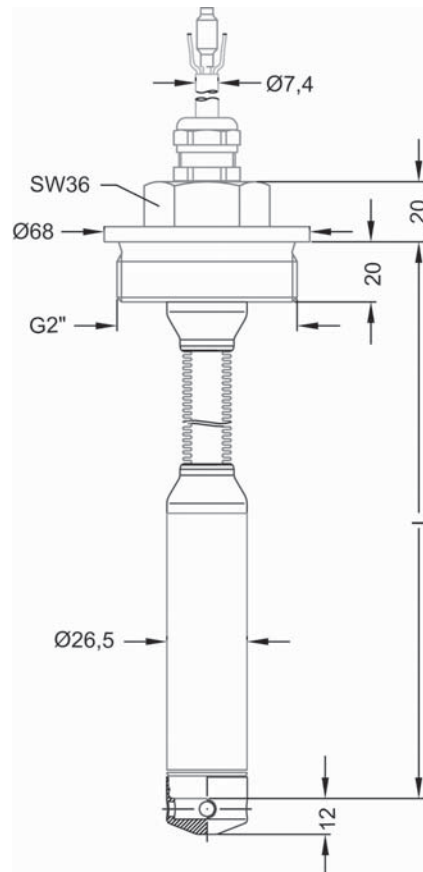

cable protection
with corrugated pipe

⇒ Total length of devices with accuracy 0.1 % FSO IEC 60770 increases by 35 mm!



LMP 307T

Stainless Steel Probe

Stainless Steel Sensor and Temperature Sensor

accuracy according to IEC 60770:
standard: 0.35 % FSO
option: 0.25 % FSO

Nominal pressure

from 0 ... 1 mH₂O up to 0 ... 250 mH₂O

Output signals

2-wire: 4 ... 20 mA (pressure)
2-wire: 4 ... 20 mA (temperature)
others on request

Special characteristics

- ▶ diameter 27 mm
- ▶ separate output signals for pressure and temperature ranges
- ▶ integrated Pt 100 thermal element
- ▶ small thermal effect
- ▶ high accuracy
- ▶ easy handling

Optional versions

- ▶ different kinds of cables
- ▶ different kinds of seal materials
- ▶ customer specific versions

BD|SENSORS has developed the stainless steel submersible probe LMP 307T for continuous level and temperature measurement in water and in clean to lightly-soiled liquids.

The advantage: simultaneous recording of level and temperature with separate independent signal amplification. The maintenance and wiring costs are considerably reduced.

In addition to classical signal processing of the level, an additional signal circuit independent of the level which converts the temperature signal into a 4 ... 20 mA analogue signal in 2-wire technology is provided.

Typical application areas are, for example, drinking water purification, monitoring of rainwater overflow basins and river courses, in addition to level measurement in containers or tank batteries.

Preferred areas of use are



Water / filtrated sewage
e.g. drinking water system

water recycling



Fuel / Oil
e.g. tank farm



Input pressure range														
Nominal pressure gauge [bar]	0.1	0.16	0.25	0.4	0.6	1	1.6	2.5	4	6	10	16	25	
Level [mH ₂ O]	1	1.6	2.5	4	6	10	16	25	40	60	100	160	250	
Overpressure [bar]	0.5	1	1	2	5	5	10	10	20	40	40	80	80	
Burst pressure ≥ [bar]	1.5	1.5	1.5	3	7.5	7.5	15	15	25	50	50	120	120	
Input temperature range														
Temperature measuring range	standard				0 ... 30 °C			0 ... 50 °C			-10 ... 50 °C			
	others on request ¹													
¹ max. temperature range + 70 °C														
Output signal / Supply														
2-wire (pressure) ²	4 ... 20 mA / V _S = 10 ... 30 V _{DC}													
2-Leiter (temperature) ²	4 ... 20 mA / V _S = 10 ... 30 V _{DC}													
² the circuits are galvanically isolated from each other														
Performance														
Accuracy (pressure) ³	standard:				nominal pressure < 0.4 bar:			≤ ± 0.5 % FSO						
					nominal pressure ≥ 0.4 bar:			≤ ± 0.35 % FSO						
	option 1:				nominal pressure ≥ 0.4 bar:			≤ ± 0,25 % FSO						
Accuracy (temperature)	≤ ± 1 °C													
Permissible load	R _{max} = [(V _S - V _S min) / 0.02 A] Ω													
Influence effects	supply:				0.05 % FSO / 10 V									
	load:				0.05 % FSO / kΩ									
Long term stability	≤ ± 0.1 % FSO / year													
Response time	< 10 ms (for output signal 2-wire (pressure))													
³ accuracy according to IEC 60770 – limit point adjustment (non-linearity, hysteresis, repeatability)														
Thermal effects (Offset and Span)														
Nominal pressure P _N [bar]					< 0.40						≥ 0.40			
Tolerance band [% FSO]					≤ ± 1						≤ ± 0.75			
in compensated range [°C]											0 ... 70			
Permissible temperatures														
Permissible temperatures	medium:				-10 ... 70 °C									
	storage:				-25 ... 70 °C									
Electrical protection ⁴														
Short-circuit protection	permanent													
Reverse polarity protection	no damage, but also no function													
Electromagnetic compatibility	emission and immunity according to EN 61326													
⁴ additional external overvoltage protection unit in terminal box KL 1 or KL 2 with atmospheric pressure reference available on request														
Electrical connection														
Cable with sheath material ⁵	PVC	(-5 ... 70 °C)		grey										
	PUR	(-10 ... 70 °C)		black										
	FEP	(-10 ... 70 °C)		black										
	others on request													
⁵ cable with integrated air tube for atmospheric pressure reference														
Materials (media wetted)														
Housing	stainless steel 1.4404 (316L)													
Seals	FKM others on request													
Diaphragm	stainless steel 1.4435 (316L)													
Protection cap	POM													
Cable sheath	PVC, PUR, FEP													
Miscellaneous														
Connecting cables (by factory)	cable capacitance:				signal line/shield also signal line/signal line: 160 pF/m									
	cable inductance:				signal line/shield also signal line/signal line: 1 □H/m									
Current consumption	signal output current:				max. 25 mA / signal output voltage: max. 7 mA									
Weight	approx. 200 g (without cable)													
Ingress protection	IP 68													
CE-conformity	EMC Directive: 2004/108/EC													

Wiring diagram

2x2-wire-system (current)

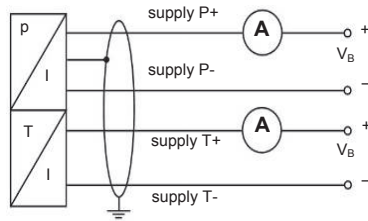

Pin configuration

Electrical connection	cable colours (DIN 47100)
Supply P+	wh (white)
Supply P-	bn (brown)
Supply P+	gy (gray)
Supply P-	pk (pink)
Shield	ye/gn (yellow / green)

Dimensions (in mm)

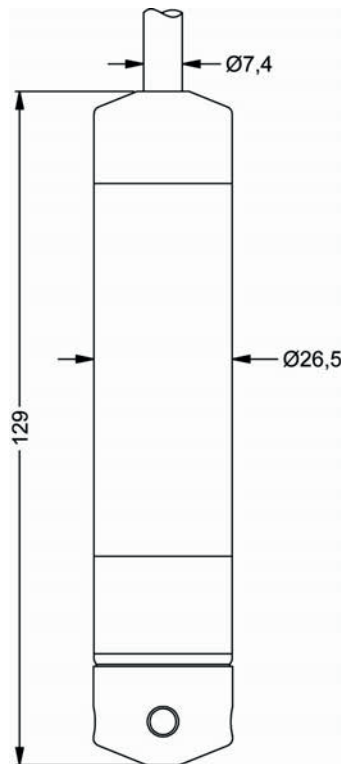



LMP 308

Separable Stainless Steel Probe

Stainless Steel Sensor

accuracy according to IEC 60770:
standard: 0.35 % FSO
option: 0.25 % FSO / 0.1 % FSO

Nominal pressure

from 0 ... 1 mH₂O up to 0 ... 250 mH₂O

Output signals

2-wire: 4 ... 20 mA
others on request

Special characteristics

- ▶ diameter 35 mm
- ▶ cable and sensor section separable
- ▶ excellent accuracy
- ▶ excellent long term stability

Optional versions

- ▶ IS-version zone 0
- ▶ SIL 2 (Safety Integrity Level)
- ▶ cable protection via corrugated pipe
- ▶ mounting accessories as cable gland and terminal clamp of stainless steel
- ▶ different kinds of cables
- ▶ different kinds of seal materials

The separable stainless steel probe LMP 308 is designed for the continually level measurement of water and thin fluids.

In order to facilitate stock-keeping and maintenance the transmitter head is plugged to the cable assembly with a connector and can be changed easily.

Preferred areas of use are

Water / filtrated sewage



- ground water level measurement
- level measurement in wells and open waters
- rain spillway basin
- level measurement in container
- water treatment plants
- water recycling



Input pressure range														
Nominal pressure gauge	[bar]	0.10	0.16	0.25	0.40	0.60	1	1.6	2.5	4	6	10	16	25
Level	[mH ₂ O]	1	1.6	2.5	4	6	10	16	25	40	60	100	160	250
Overpressure	[bar]	0.5	1	1	2	5	5	10	10	20	40	40	80	80
Burst pressure	[bar]	1.5	1.5	1.5	3	7.5	7.5	15	15	25	50	50	120	120
Output signal / Supply														
Standard		2-wire: 4 ... 20 mA / V _S = 8 ... 32 V _{DC}												
Option IS-protection		2-wire: 4 ... 20 mA / V _S = 10 ... 28 V _{DC}												
Performance														
Accuracy ¹		standard: nominal pressure < 0.4 bar: ≤ ± 0.5 % FSO nominal pressure ≥ 0.4 bar: ≤ ± 0.35 % FSO option 1: nominal pressure ≥ 0.4 bar: ≤ ± 0.25 % FSO option 2: for all nominal pressures: ≤ ± 0.1 % FSO												
Permissible load		R _{max} = [(V _S - V _{Smin}) / 0.02 A] Ω												
Influence effects		supply: 0.05 % FSO / 10 V load: 0.05 % FSO / kΩ												
Long term stability		≤ ± 0.1 % FSO / year												
Response time		< 10 msec												
¹ accuracy according to IEC 60770 – limit point adjustment (non-linearity, hysteresis, repeatability)														
Thermal effects (Offset and Span)														
Nominal pressure P _N	[bar]	< 0.40										≥ 0.40		
Tolerance band	[% FSO]	≤ ± 1										≤ ± 0.75		
in compensated range	[°C]	0 ... 70												
Permissible temperatures														
Permissible temperatures		medium: -20 ... 70 °C										storage: -25 ... 70 °C		
Electrical protection ²														
Short-circuit protection		permanent												
Reverse polarity protection		no damage, but also no function												
Electromagnetic compatibility		emission and immunity according to EN 61326												
² additional external overvoltage protection unit in terminal box KL 1 or KL 2 with atmospheric pressure reference available on request														
Electrical connection														
Cable with sheath material ³		PVC (-5 ... 70 °C) grey PUR (-20 ... 70 °C) black FEP (-20 ... 70 °C) black others on request												
³ cable with integrated air tube for atmospheric pressure reference														
Materials (media wetted)														
Housing		stainless steel 1.4404 (316L)												
Seals		FKM EPDM others on request												
Diaphragm		stainless steel 1.4435 (316L)												
Protection cap		POM												
Explosion protection														
Approvals DX19-LMP 308		IBExU 10 ATEX 1068 X / IECEx IBE 12.0027X zone 0: II 1G Ex ia IIC T4 Ga zone 20: II 1D Ex ia IIIC T 85°C Da												
Safety technical maximum values		U _i = 28 V, I _i = 93 mA, P _i = 660 mW, C _i ≈ 0nF, L _i ≈ 0μH, the supply connections have an inner capacity of max. 27 nF to the housing												
Permissible media temperature		in zone 0: -20 ... 60 °C with p _{atm} 0.8 bar up to 1.1 bar in zone 1 or higher: -20 ... 70 °C												
Connecting cables (by factory)		cable capacitance: signal line/shield also signal line/signal line: 160 pF/m cable inductance: signal line/shield also signal line/signal line: 1μH/m												
Miscellaneous														
Option SIL ⁴ 2 application		according to IEC 61508 / IEC 61511												
Current consumption		signal output current: max. 25 mA												
Weight		approx. 250 g (without cable)												
Ingress protection		IP 68												
CE-conformity		EMC Directive: 2004/108/EC												
ATEX Directive		94/4/EG												
⁴ not in combination with the accuracy 0.1%														

Wiring diagram

2-wire-system (current)

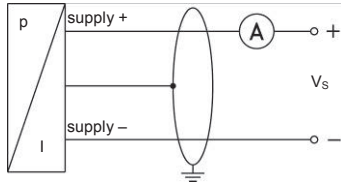

connector

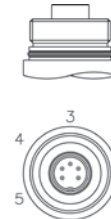

Pin configuration

Electrical connection	Binder series 723 ⁵ (5-pin)	cable colours (DIN 47100)
Supply +	3	wh (white)
Supply -	1	bn (brown)
Shield	5	gn/ye (green / yellow)

⁵ in separated version

Dimensions (in mm)

standard

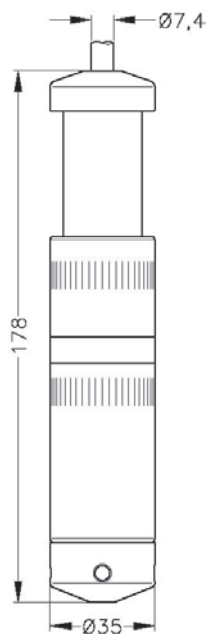

option

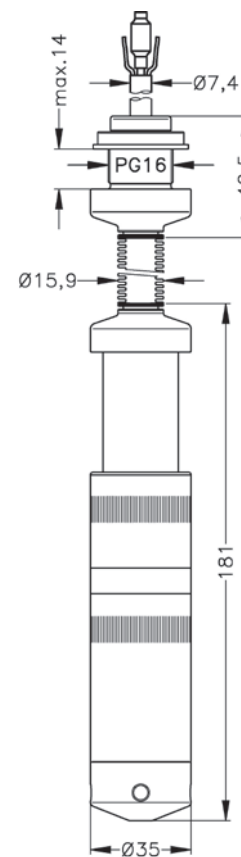

separated version

version with
corrugated pipe

⇒ Total length of devices with accuracy 0.1 % FSO IEC 60770 increases by 16 mm!
(standard, Ex-protection and SIL-version)



LMK 306

Stainless Steel Probe

Ceramic Sensor

accuracy according
to IEC 60770: 0.5 % FSO

Nominal pressure

from 0 ... 6 mH₂O up to 0 ... 200 mH₂O

Output signals

2-wire: 4 ... 20 mA
others on request

Special characteristics

- ▶ diameter 17 mm
- ▶ suitable for hydrostatic level measurement e.g. 3/4" pipes
- ▶ excellent linearity
- ▶ excellent long term stability

Optional versions

- ▶ different cable materials
- ▶ customer specific versions e.g. special pressure ranges

The slimline probe LMK 306 with ceramic sensor has been especially designed for the continuous level measurement at confined space conditions. Permissible media are clean or slightly contaminated water and thin fluids.

Different cable sheath materials are available in order to achieve maximum media compatibility.

Preferred areas of use are

Water



- level measurement at confined space conditions
- ground water monitoring
- depth or level measurement in wells
- drinking water abstraction
- level measurement in open tanks



Input pressure range										
Nominal pressure gauge	[bar]	0.6	1	1.6	2.5	4	6	10	16	20
Level	[mH ₂ O]	6	10	16	25	40	60	100	160	200
Overpressure	[bar]	2	2	4	4	10	10	20	40	40
Burst pressure ≥	[bar]	4	4	5	5	12	12	25	50	50

Output signal / Supply	
Standard	2-wire: 4 ... 20 mA / V _S = 12 ... 36 V _{DC}
Performance	
Accuracy	≤ ± 0.5 % FSO
Permissible load	R _{max} = [(V _S - V _{S min}) / 0.02 A] Ω
Influence effects	supply: 0.05 % FSO / 10 V load: 0.05 % FSO / kΩ
Response time	≤ 10 msec

¹ accuracy according to IEC 60770 – limit point adjustment (non-linearity, hysteresis, repeatability)

Thermal effects (Offset and Span) / Permissible temperatures	
Thermal error	≤ ± 0.2 % FSO / 10 K in compensated range -25 ... 70 °C
Permissible temperatures	medium: -10 ... 70 °C storage: -25 ... 70 °C

Electrical protection ²	
Short-circuit protection	permanent
Reverse polarity protection	no damage, but also no function
Electromagnetic protection	emission and immunity according to EN 61326

² additional external overvoltage protection unit in terminal box KL 1 or KL 2 with atmospheric pressure reference available on request

Electrical connection	
Cable with sheath material ³	PVC (-5 ... 70 °C) grey PUR (-10 ... 70 °C) black FEP (-10 ... 70 °C) black

³ shielded cable with integrated air tube for atmospheric pressure reference

Materials (media wetted)	
Housing	stainless steel 1.4404 (316L)
Seals	FKM
Diaphragm	ceramics Al ₂ O ₃ 96 %
Protection cap	POM

Miscellaneous	
Connecting cables (by factory)	cable capacitance: signal line/shield also signal line/signal line: 160 pF/m cable inductance: signal line/shield also signal line/signal line: 1 μH/m
Current consumption	max. 25 mA
Weight	approx. 100 g (without cable)
Ingress protection	IP 68
CE-conformity	EMC Directive: 2004/108/EC

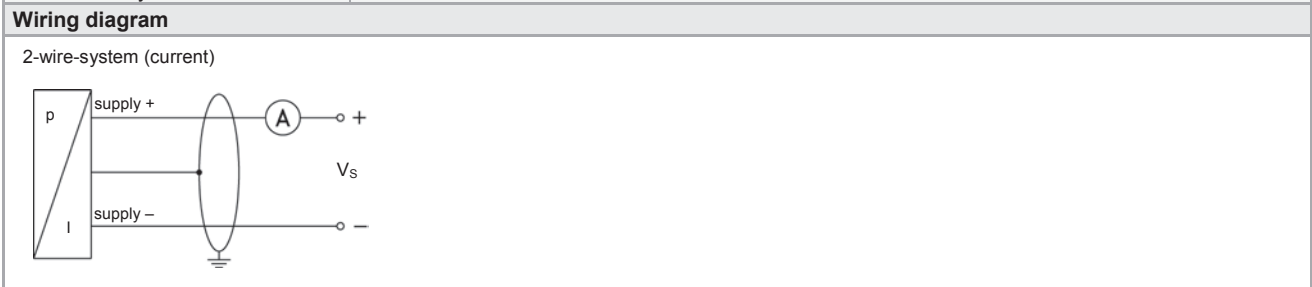

Pin configuration	
Electrical connection	cable colours (DIN 47100)
Supply +	wh (white)
Supply -	bn (brown)
Shield	gn/ye (green / yellow)
Dimensions (in mm)	



LMK 307

Stainless Steel Probe

Ceramic Sensor

accuracy according to IEC 60770: 0.5 % FSO

Nominal pressure

from 0 ... 4 mH₂O up to 0 ... 250 mH₂O

Output signals

2-wire: 4 ... 20 mA

3-wire: 0 ... 20 mA / 0 ... 10 V

others on request

Special characteristics

- ▶ diameter 27 mm
- ▶ good linearity
- ▶ good long term stability
- ▶ easy handling

Optional versions

- ▶ IS-protection
- ▶ SIL 2 (Safety Integrity Level) according to IEC 61508 / IEC 61511
- ▶ different kinds of cables and elastomers
- ▶ customer specific versions e. g. special pressure ranges

The level transmitter LMK 307 is designed for continuous level measurement in water or waste water applications. Basic element is a flush mounted ceramic sensor.

Suitable for all fluids which are compatible with media wetted materials. Different cable and elastomer materials can be offered according to the customer-specific operating conditions.

Preferred areas of use are

Water



drinking water system
ground water monitoring
storm water systems

Sewage



waste water treatment
water recycling
dumpsite

Fuel / Oil



fuel storage
tank farm
biogas plants



Input pressure range											
Nominal pressure gauge	[bar]	0.4	0.6	1	1.6	2.5	4	6	10	16	25
Level	[mH ₂ O]	4	6	10	16	25	40	60	100	160	250
Overpressure	[bar]	2	2	2	4	4	10	10	20	40	40
Burst pressure	[bar]	4	4	4	5	5	12	12	25	50	50

Output signal / Supply	
Standard	2-wire: 4 ... 20 mA / $V_S = 8 \dots 32 V_{DC}$
Option IS-protection	2-wire: 4 ... 20 mA / $V_S = 10 \dots 28 V_{DC}$
Options 3-wire	3-wire: 0 ... 20 mA / $V_S = 14 \dots 30 V_{DC}$ 0 ... 10 V / $V_S = 14 \dots 30 V_{DC}$

Performance	
Accuracy	$\leq \pm 0.5 \% \text{ FSO}$
Permissible load	current 2-wire: $R_{\max} = [(V_S - V_{S \min}) / 0.02 \text{ A}] \Omega$ current 3-wire: $R_{\max} = 500 \Omega$ voltage 3-wire: $R_{\min} = 10 \text{ k} \Omega$
Influence effects	supply: 0.05 % FSO / 10 V load: 0.05 % FSO / k Ω
Response time	$\leq 10 \text{ msec}$

¹ accuracy according to IEC 60770 – limit point adjustment (non-linearity, hysteresis, repeatability)

Thermal effects (Offset and Span)	
Thermal error	$\leq \pm 0.2 \% \text{ FSO} / 10 \text{ K}$ in compensated range -25 ... 70 °C

Permissible temperatures	
Permissible temperatures	medium: -10 ... 70 °C storage: -25 ... 70 °C

Electrical protection ²	
Short-circuit protection	permanent
Reverse polarity protection	no damage, but also no function
Electromagnetic protection	emission and immunity according to EN 61326

² additional external overvoltage protection unit in terminal box KL 1 or KL 2 with atmospheric pressure reference available on request

Electrical connection	
Cable with sheath material ³	PVC (-5 ... 70 °C) grey PUR (-10 ... 70 °C) black FEP (-10 ... 70 °C) black

³ shielded cable with integrated air tube for atmospheric pressure reference

Materials (media wetted)	
Housing	stainless steel 1.4404 (316L)
Seals	FKM EPDM
Diaphragm	ceramics Al ₂ O ₃ 96 %
Protection cap	POM

Explosion protection (only for 4 ... 20 mA / 2-wire)	
Approvals DX19-LMK 307	IBExU 10 ATEX 1068 X / IECEx IBE 12.0027X zone 0: II 1G Ex ia IIC T4 Ga zone 20: II 1D Ex ia IIIC T 85°C Da
Safety technical maximum values	$U_i = 28 \text{ V}$, $I_i = 93 \text{ mA}$, $P_i = 660 \text{ mW}$, $C_i \approx 0 \text{ nF}$, $L_i \approx 0 \text{ } \mu\text{H}$, the supply connections have an inner capacity of max. 27 nF to the housing
Permissible media temperature	in zone 0: -10 ... 60 °C with p_{atm} 0.8 bar up to 1.1 bar in zone 1: -10 ... 70 °C
Connecting cables (by factory)	cable capacitance: signal line/shield also signal line/signal line: 160 pF/m cable inductance: signal line/shield also signal line/signal line: 1 $\mu\text{H}/\text{m}$

Miscellaneous	
Option SIL ⁴ 2 application	according to IEC 61508 / IEC 61511
Current consumption	signal output current: max. 25 mA signal output voltage: max. 7 mA
Weight	approx. 250 g (without cable)
Ingress protection	IP 68
CE-conformity	EMC Directive: 2004/108/EC
ATEX Directive	94/4/EG

⁴ only for 4...20mA / 2-wire

Wiring diagrams

2-wire-system (current)

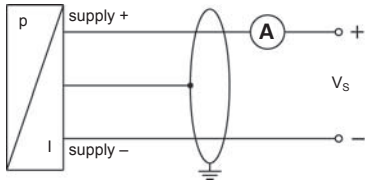

3-wire-system (current / voltage)

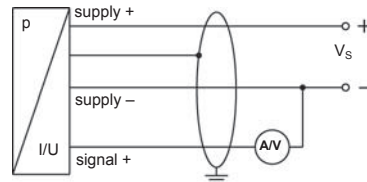

Pin configuration

Electrical connection	cable colours (DIN 47100)
Supply +	wh (white)
Supply -	bn (brown)
Signal + (only 3-wire)	gn (green)
Shield	ye/gn (yellow / green)

Dimensions (in mm)

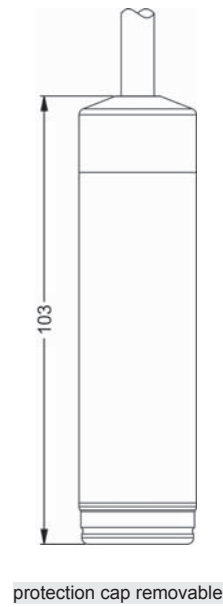
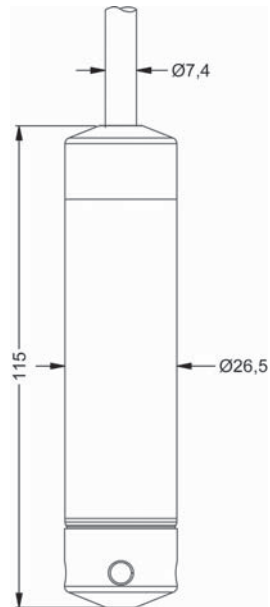



LMK 382

Stainless Steel Probe

Ceramic Sensor

accuracy according to IEC 60770:
 standard: 0.35 % FSO
 option: 0.25 % FSO

Nominal pressure

from 0 ... 40 cmH₂O up to 0 ... 200 mH₂O

Output signals

- 2-wire: 4 ... 20 mA
- 3-wire: 0 ... 10 V
- others on request

Special characteristics

- ▶ diameter 39.5 mm
- ▶ especially for sewage, viscous and pasty media

Optional versions

- ▶ IS-protection zone 0
- ▶ mounting with stainless steel pipe
- ▶ flange version
- ▶ diaphragm 99.9 % Al₂O₃
- ▶ different kinds of cables
- ▶ different kinds of elastomers

The stainless steel probe LMK 382 has been designed for continuous level measurement in waste water, waste and higher viscosity media.

Basic element is a robust and high overpressure capable capacitive ceramic sensor e.g. for low levels easily.

Preferred areas of use are



Water
 drinking water abstraction



Sewage
 waste water treatment
 water recycling



Fuel / Oil
 level monitoring in open tanks
 with low filling heights
 fuel storage
 tank farms / biogas plants



Input pressure range																
Nominal pressure gauge	[bar]	0.04	0.06	0.1	0.16	0.25	0.4	0.6	1	1.6	2.5	4	6	10	16	20
Level	[mH ₂ O]	0.4	0.6	1	1.6	2.5	4	6	10	16	25	40	60	100	160	200
Overpressure	[bar]	2	2	4	4	6	6	8	8	15	25	25	35	35	45	45

Output signal / Supply	
Standard	2-wire: 4 ... 20 mA / V _S = 9 ... 32 V _{DC}
Option IS-protection	2-wire: 4 ... 20 mA / V _S = 14 ... 28 V _{DC}
Option 3-wire	3-wire: 0 ... 10 V / V _S = 12.5 ... 32 V _{DC}

Performance	
Accuracy ¹	standard: ≤ ± 0.35 % FSO option: ≤ ± 0.25 % FSO
Permissible load	$R_{max} = [(V_S - V_{Smin}) / 0.02 A] \Omega$
Influence effects	supply: 0.05 % FSO / 10 V load: 0.05 % FSO / kΩ
Long term stability	≤ ± 0.1 % FSO / year
Turn-on time	700 msec
Mean response time	< 200 msec
Max. response time	380 msec

¹ accuracy according to IEC 60770 – limit point adjustment (non-linearity, hysteresis, repeatability)

Thermal effects (Offset and Span)	
Thermal error	≤ ± 0.1 % FSO / 10 K in compensated range 0 ... 70 °C

Permissible temperatures	
Permissible temperatures	medium: -25 ... 125 °C electronics / environment: -25 ... 125 °C storage: -25 ... 125 °C

Electrical protection ²	
Short-circuit protection	permanent
Reverse polarity protection	no damage, but also no function
Electromagnetic compatibility	emission and immunity according to EN 61326

² additional external overvoltage protection unit in terminal box KL 1 or KL 2 with atmospheric pressure reference available on request

Electrical connection (only for 4 ... 20 mA / 2-wire)	
Cable with sheath material ³	PVC (-5 ... 70 °C) grey PUR (-25 ... 70 °C) black FEP (-25 ... 70 °C) black TPE (-25 ... 125 °C) blue

³ shielded cable with integrated air tube for atmospheric pressure reference

Materials (media wetted)	
Housing	stainless steel 1.4404 (316 L)
Seals	FKM FFKM EPDM others on request
Diaphragm	standard: ceramics Al ₂ O ₃ 96 % Option: ceramics Al ₂ O ₃ 99.9 %
Nose cone	POM

Explosion protection	
Approval DX14-LMK 382	zone 0 ⁴ : II 1G Ex ia IIB T4 Ga zone 20: II 1D Ex iaD 20 T 85°C
Safety technical maximum values	U _i = 28 V, I _i = 93 mA, P _i = 660 mW, C _i = 27 nF, L _i = 5 μH
Permissible media temperature	in zone 0: -10 ... 60 °C with p _{atm} 0.8 bar up to 1.1 bar zone 1 and higher: -10 ... 70 °C
Connecting cables (by factory)	cable capacitance: signal line/shield also signal line/signal line: 160 pF/m cable inductance: signal line/shield also signal line/signal line: 1 μH/m

⁴ for optional stainless steel pipe following designation is valid: "II 1G Ex ia IIC T4 Ga" (zone 0)

Miscellaneous	
Current consumption	max. 21 mA
Weight	approx. 400 g (without cable)
Ingress protection	IP 68
CE-conformity	EMC Directive: 2004/108/EC

Wiring diagram

2-wire-system (current)

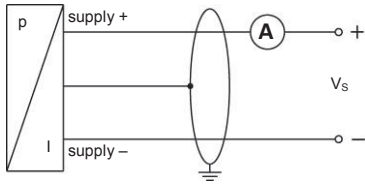

3-wire-system (voltage)

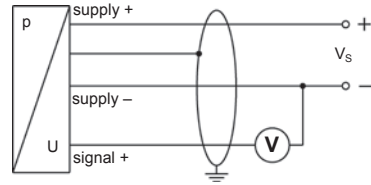

Pin configuration

Electrical connection	cable colours (DIN 47100)
Supply +	wh (white)
Supply -	bn (brown)
Signal + (only for 3-wire)	gn (green)
Shield	gn/ye (green / yellow)

Dimensions (in mm)

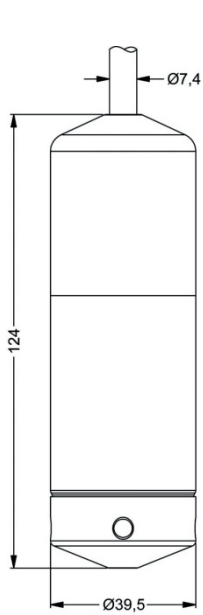

LMK 382 standard

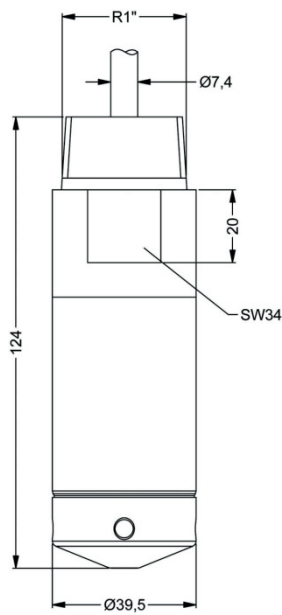

LMK 382 with thread R1" for stainless steel pipe

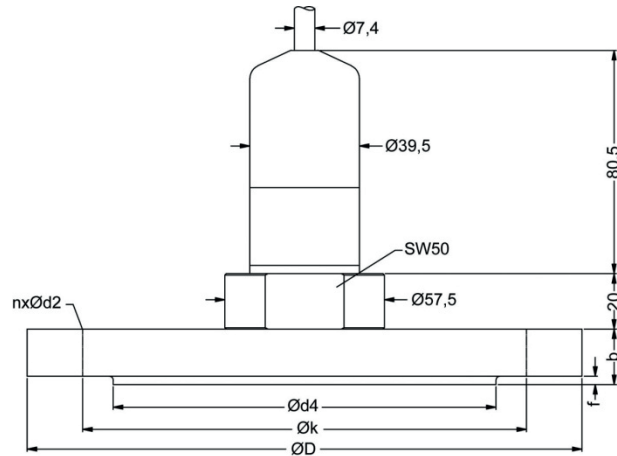

LMK 382 flange version

dimensions in mm				
dimen- sions	DN25 / PN40	DN40/ PN40	DN50 / PN40	DN80 / PN16
D	115	150	165	200
k	85	110	125	160
d4	68	88	102	138
b	18	18	20	20
f	2	3	3	3
n	4	4	4	8
d2	14	18	18	18



LMK 458

Probe For Marine And Offshore

Ceramic Sensor

accuracy according to IEC 60770:
standard: 0.25 % FSO
option: 0.1 % FSO

Nominal pressure

from 0 ... 40 cmH₂O up to 0 ... 200 mH₂O

Output signals

2-wire: 4 ... 20 mA
others on request

Special characteristics

- ▶ diameter 39.5 mm
- ▶ permissible temperatures up to 125 °C
- ▶ high overpressure resistance
- ▶ high long-term stability

Optional versions

- ▶ diaphragm Al₂O₃ 99.9 %
- ▶ different housing materials (stainless steel, CuNiFe)
- ▶ IS-version zone 0
- ▶ screw-in and flange version
- ▶ accessories e.g. assembling and probe flange, mounting clamp

The hydrostatic probe LMK 458 has been developed for measuring level in service and storage tanks and is as a consequence of the certification by Germanischer Lloyd predestined for shipbuilding and offshore applications.

A permissible operating temperature of up to 125 °C and the possibility to use the device in intrinsic safe areas enable to measure the pressure of various fluids under extreme conditions. The basis for the LMK 458 is a capacitive ceramic sensor element designed by BD|SENSORS, which offers a high overload resistance and medium compatibility.

Preferred areas of use are



Water

drinking water abstraction
desalinization plant

Shipbuilding / Offshore

ballast tanks
monitoring of a ship's position and draught
level measurement in ballast and storage tanks



Pressure ranges																	
Nominal pressure ¹	[bar]	0.04	0.06	0.1	0.16	0.25	0.4	0.6	1	1.6	2.5	4	6	10	16	20	
Level	[mH ₂ O]	0.4	0.6	1	1.6	2.5	4	6	10	16	25	40	60	100	160	200	
Overpressure	[bar]	2	2	4	4	6	6	8	8	15	25	25	35	35	45	45	
Permissible vacuum	[bar]	-0.2		-0.3		-0.5				-1							
¹ available in gauge, sealed gauge and absolute; nominal pressure ranges sealed gauge and absolute from 1 bar																	
Output signal / Supply																	
Standard		2-wire: 4 ... 20 mA / V _S = 9 ... 32 V _{DC}						V _{S rated} = 24 V _{DC}									
Option IS-version		2-wire: 4 ... 20 mA / V _S = 14 ... 28 V _{DC}						V _{S rated} = 24 V _{DC}									
Performance																	
Accuracy ²		standard: ≤ ± 0.25 % FSO						option: for P _N ≥ 0.6 bar ³ : ≤ ± 0.1 % FSO									
Permissible load		R _{max} = [(V _S - V _{S min}) / 0.02 A] Ω															
Long term stability		≤ ± 0.1 % FSO / year															
Influence effects		supply: 0.05 % FSO / 10 V						permissible load: 0.05 % FSO / kΩ									
Turn-on time		700 msec															
Mean response time		< 200 msec						mean measuring rate 5/sec									
Max. response time		380 msec															
² accuracy according to IEC 60770 – limit point adjustment (non-linearity, hysteresis, repeatability)																	
³ Under the influence of disturbance burst according to EN 61000-4-4 (2004) +2 kV accuracy decreased to ≤ ± 0.25 % FSO.																	
Thermal effects / Permissible temperatures																	
Thermal error		≤ ± 0.1 % FSO / 10 K						in compensated range -20 ... 80 °C									
Permissible temperatures		medium / electronics / environment: -25 ... 125 °C (depending on cable sheath / seal) storage: -40 ... 125 °C															
Electrical protection ⁴																	
Short-circuit protection		permanent															
Reverse polarity protection		no damage, but also no function															
Electromagnetic compatibility		emission and immunity according to - EN 61326 - Germanischer Lloyd (GL) - Det Norske Veritas (DNV)															
⁴ additional external overvoltage protection unit in terminal box KL 1 or KL 2 with atmospheric pressure reference available																	
Mechanical stability																	
Vibration		4 g (according to GL: curve 2 / according to DNV: Class B / basis: DIN EN 60068-2-6)															
Electrical connection																	
Cable outlet		shielded cable with integrated air tube for atmospheric reference (for nominal pressure ranges sealed gauge and absolute, the air tube is plugged)															
Materials																	
Housing		standard: stainless steel 1.4404 (316L)						option: CuNi10Fe1Mn (resistant against sea water)						others on request			
Seals (media wetted)		standard: FKM						options: EPDM, FFKM (min. permissible temperature from -15 °C)						others on request			
Diaphragm		standard: ceramics Al ₂ O ₃ 96 %						option: ceramics Al ₂ O ₃ 99.9 %									
Cable sheath		standard: TPE (-25 ... 125 °C)				dark blue (resistant against sea water, halogen free)				option: FEP (-25 ... 70 °C)				black (resistant against sea water)			
		PUR (-25 ... 70 °C)				black				others on request							
Miscellaneous																	
Optionally cable protection		stainless steel pipe for probe in stainless steel: available as compact product (standard: stainless steel pipe with a total length up to 2 m possible; other lengths on request)															
Ingress protection		IP 68															
Current consumption		max. 21 mA															
Weight		min. 650 g (without cable)															
CE-conformity		EMC Directive: 2004/108/EC															
Option Pt 100 temperature element ⁵																	
Temperature range		-25 ... 125 °C															
Connection temperature element		3-wire															
Resistance		100 Ω at 0 °C															
Temperature coefficient		3850 ppm/K															
Supply I _S		0.3 ... 1.0 mA _{DC}															
IS-protection																	
Approval DX14A-LMK 458		zone 0: II 1G Ex ia IIB T4															
Safety technical maximum values		U _i = 28 V, I _i = 93 mA, P _i = 660 mW, C _i = 105 nF; L _i = 5 μH; the supply connections have an inner capacity of max. 140 nF opposite the enclosure															
Permissible temperatures for environment		in zone 0 ⁶ : -20 ... 60 °C with p _{atm} 0.8 bar up to 1.1 bar zone 1 and higher: -25 ... 70 °C															
Connecting cables (by factory)		cable capacity: signal line/shield as well as signal line/signal line: 160 pF/m cable inductance: signal line/shield as well as signal line/signal line: 1 μH/m															
⁵ only for 4...20mA, cable length max. 5m																	
⁶ for optional stainless steel pipe the following designation is valid: "II 1 G Ex ia IIC T4" (zone 0)																	

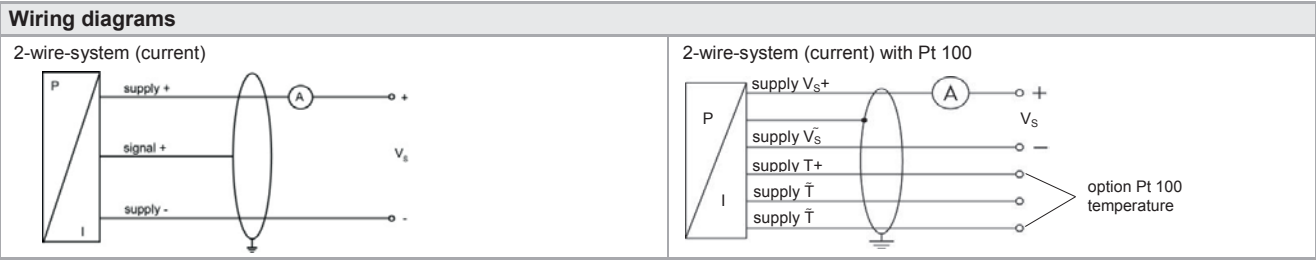

Pin configuration

Electrical connection	cable colours (DIN 47100)
Supply V _s + Supply V _s -	wh (white) bn (brown)
Option Pt 100 temperature element: Supply T+ (with Pt 100) Supply T- (with Pt 100) Supply T- (with Pt 100)	ye (yellow) gy (grey) pk (pink)
Shield	gn/ye (green / yellow)

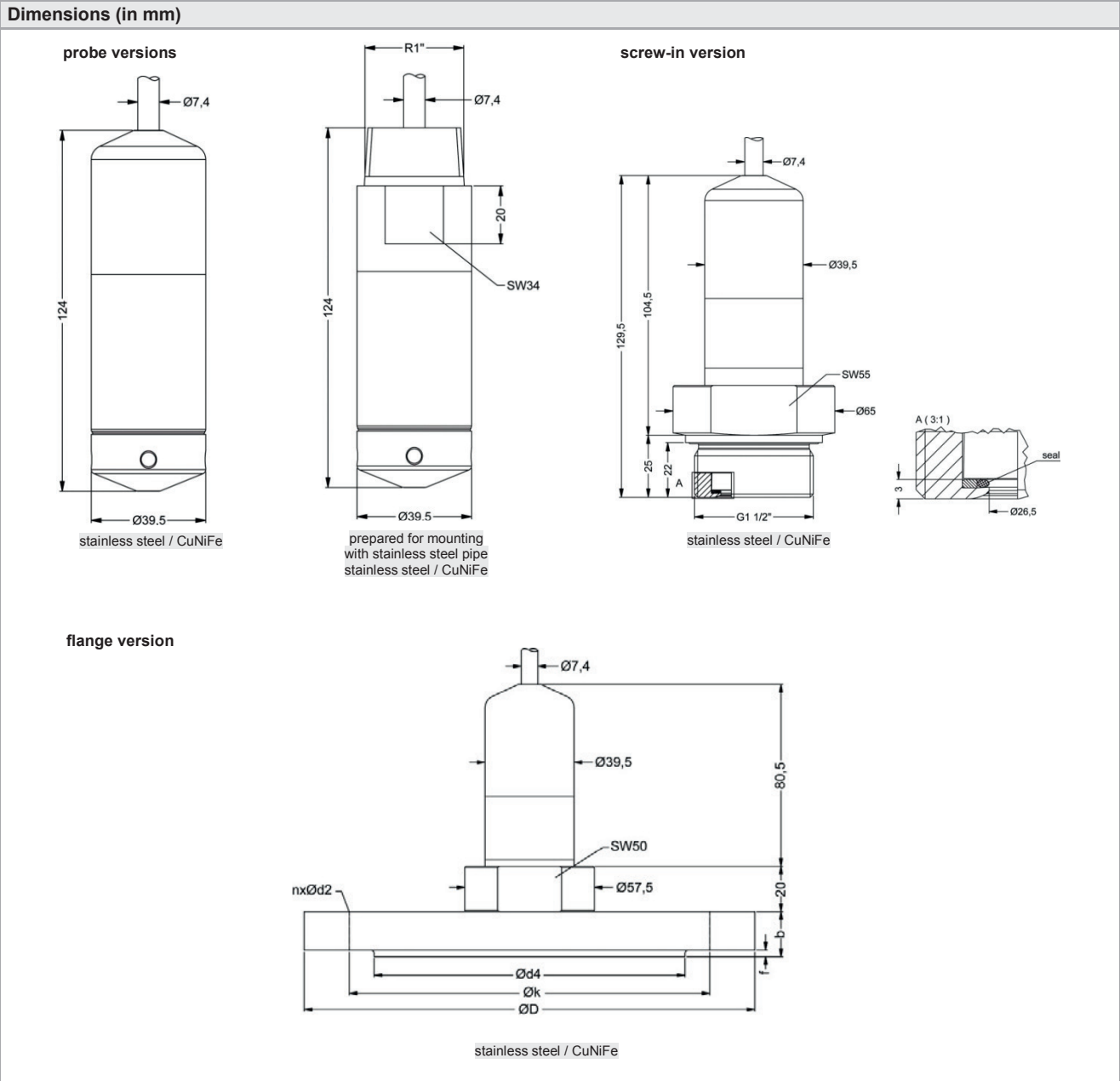



LMK 358

Separable Stainless Steel Probe

Ceramic Sensor

accuracy according to IEC 60770:
standard: 0.35 % FSO
option: 0.25 % FSO

Nominal pressure

from 0 ... 40 cmH₂O up to 0 ... 100 mH₂O

Output signals

2-wire: 4 ... 20 mA
3-wire: 0 ... 10 V
others on request

Special characteristics

- ▶ cable and probe separable
- ▶ diameter 39.5 mm
- ▶ especially for sewage, viscous and pasty media

Optional versions

- ▶ IS-protection zone 0
- ▶ cable protection via corrugated pipe
- ▶ diaphragm 99.9 % Al₂O₃
- ▶ different kinds of cable
- ▶ different kinds of elastomers

The separable stainless steel probe LMK 358 has been designed for level measurement in waste water, waste and higher viscosity media. Basic element is a capacitive ceramic sensor.

In order to facilitate stock-keeping and maintenance the transmitter head is plugged to the cable assembly with a connector and can be changed easily.

Preferred areas of use are



Water

ground water level measurement
rain spillway basin



Sewage

waste water treatment
water recycling



Fuel / Oil

level monitoring in open tanks
with low filling heights
fuel storage
tank farms / biogas plants



Input pressure range														
Nominal pressure gauge	[bar]	0.04	0.06	0.1	0.16	0.25	0.4	0.6	1	1.6	2.5	4	6	10
Level	[mH ₂ O]	0.4	0.6	1	1.6	2.5	4	6	10	16	25	40	60	100
Overpressure	[bar]	2	2	4	4	6	6	8	8	15	25	25	35	35

Output signal / Supply	
Standard	2-wire: 4 ... 20 mA / V _S = 9 ... 32 V _{DC}
Option IS-protection	2-wire: 4 ... 20 mA / V _S = 14 ... 28 V _{DC}
Option 3-wire	3-wire: 0 ... 10 V / V _S = 12.5 ... 32 V _{DC}

Performance	
Accuracy ¹	standard: ≤ ± 0.35 % FSO option: ≤ ± 0.25 % FSO
Permissible load	R _{max} = [(V _S - V _{S min}) / 0.02 A] Ω
Influence effects	supply: 0.05 % FSO / 10 V load: 0.05 % FSO / kΩ
Long term stability	≤ ± 0.1 % FSO / year
Turn-on time	700 msec
Mean response time	< 200 msec
Max. response time	380 msec

¹ accuracy according to IEC 60770 – limit point adjustment (non-linearity, hysteresis, repeatability)

Thermal effects (Offset and Span)	
Thermal error	≤ ± 0.1 % FSO / 10 K in compensated range 0 ... 70 °C

Permissible temperatures	
Permissible temperatures	medium: -25 ... 125 °C electronic / environment: -25 ... 125 °C storage: -40 ... 125 °C

Electrical protection ²	
Short-circuit protection	permanent
Reverse polarity protection	no damage, but also no function
Electromagnetic compatibility	emission and immunity according to EN 61326

² additional external overvoltage protection unit in terminal box KL 1 or KL 2 with atmospheric pressure reference available on request

Electrical connection	
Cable with sheath material ³	PVC (-5 ... 70 °C) grey PUR (-25 ... 70 °C) black FEP (-25 ... 70 °C) black TPE (-25 ... 125 °C) blue

³ shielded cable with integrated air tube for atmospheric pressure reference

Materials (media wetted)	
Housing	stainless steel 1.4404 (316L)
Seals	FKM EPDM others on request
Diaphragm	standard: ceramics Al ₂ O ₃ 96 % option: ceramics Al ₂ O ₃ 99.9 %
Nose cone	POM

Explosion protection (only for 4 ... 20 mA / 2-wire)	
Approval DX14-LMK 358	IBExU05ATEX1070 X Zone 0 ⁴ : II 1G Ex ia IIB T4 Ga Zone 20: II 1D Ex iaD 20 T 85°C
Safety technical maximum values	U _i = 28 V, I _i = 93 mA, P _i = 660 mW, C _i = 27 nF, L _i = 5 μH
Permissible temperature	-25 ... 70 °C
Connecting cables (by factory)	cable capacitance: signal line/shield also signal line/signal line: 100 pF/m cable inductance: signal line/shield also signal line/signal line: 1 μH/m

⁴ for optional stainless steel pipe following designation is valid: "II 1G Ex ia IIC T4 Ga" (zone 0)

Miscellaneous	
Current consumption	max. 21 mA
Weight	approx. 650 g (without cable)
Ingress protection	IP 68
CE-conformity	EMC Directive: 2004/108/EC

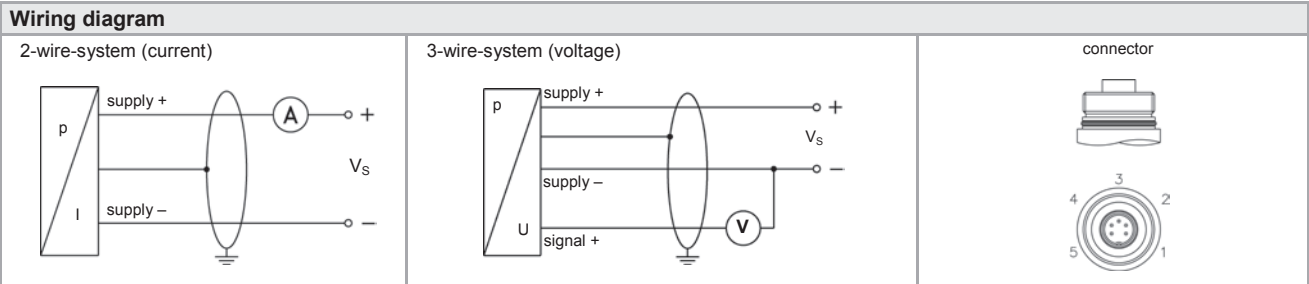

Pin configuration

Electrical connection	Binder series 723 ⁵ (5-pin)		cable colours (DIN 47100)
	2 - wire	3 - wire	
Supply +	3	3	wh (white)
Supply -	1	4	bn (brown)
Signal + (only for 3-wire)	-	1	gn (green)
Shield	5	5	gn/ ye (green / yellow)

⁵ in separated version

Dimensions (in mm)

standard:

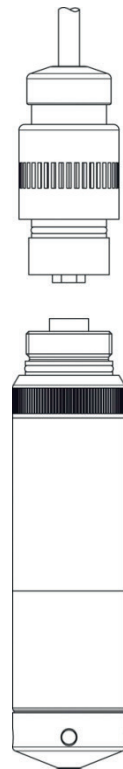
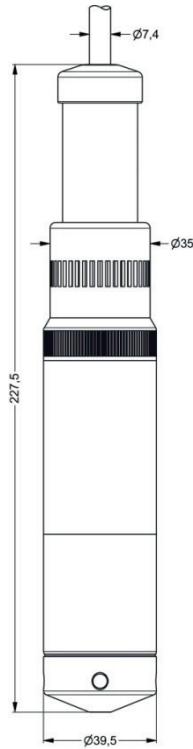

separated version

optional:

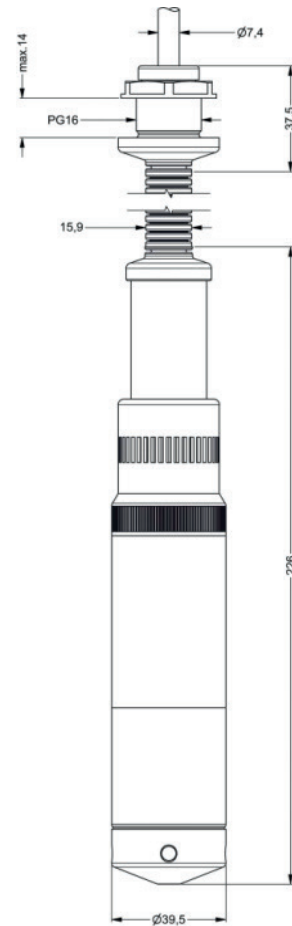

with
corrugated pipe



LMP 808

Separable Plastic Probe

Stainless Steel Sensor

accuracy according to IEC 60770:
standard: 0.35 % FSO
option: 0.25 %

Nominal pressure

from 0 ... 1 mH₂O up to 0 ... 100 mH₂O

Output signals

2-wire: 4 ... 20 mA
3-wire: 0 ... 20 mA / 0 ... 10 V
others on request

Special characteristics

- ▶ diameter 35 mm
- ▶ cable and sensor section separable
- ▶ excellent linearity
- ▶ small thermal effect

Optional versions

- ▶ SIL 2 (Safety Integrity Level) according to IEC 61508 / 61511
- ▶ mounting accessories as screw fitting and terminal clamp of stainless steel
- ▶ different kinds of cables and elastomers
- ▶ customer specific versions e. g. special pressure ranges

The separable plastic probe is designed for level measurement of water, waste water as well as fuels and oils. Basic element is a piezoresistive stainless steel sensor.

In order to facilitate stock-keeping and maintenance the transmitter head is plugged to the cable assembly with a connector and can be changed easily.

Preferred areas of use are

Water / filtrated sewage

ground water level measurement
storm water systems
drinking water system
water treatment plants



Fuel / Oil

fuel storage
tank farm
biogas plants
process water recycling



Wiring diagrams

2-wire-system (current)

3-wire-system (current / voltage)

connector

Pin configuration

Electrical connection	Binder serie 723 ⁵ (5-pin)	cable colours (DIN 47100)
Supply +	3	wh (white)
Supply - (only 2-wire)	1	bn (brown)
Supply - (only 3-wire)	4	bn (brown)
Signal + (only 3-wire)	1	gn (green)
Shield	5	gn/ye (green / yellow)

⁵ in separated version

Dimensions (in mm)

standard

standard version
without cable protection

option

separate version

cable protection with PVC pipe

This document contains product specifications; properties are not guaranteed. Subject to change without notice.



LMK 807

Plastic Probe for Aggressive Media

Ceramic Sensor

accuracy according to IEC 60770: 0.5 % FSO

Nominal pressure

from 0 ... 4 mH₂O up to 0 ... 100 mH₂O

Output signals

2-wire: 4 ... 20 mA
others on request

Special characteristics

- ▶ diameter 35 mm
- ▶ excellent long term stability
- ▶ easy handling

Optional versions

- ▶ SIL 2 (Safety Integrity Level) according to IEC 61508 / IEC 61511
- ▶ different kinds of cables and elastomers
- ▶ customer specific version e. g. special pressure ranges

The plastic submersible probe LMK 807 is designed for continuous level measurement for waste water or and different aggressive media.

Basic element of the plastic submersible probe is the flush mounted ceramic sensor, which makes cleaning easier when solid parts of the medium deposit on it. Different cable and elastomer materials are available in order to achieve maximum media compatibility.

Preferred areas of use are

Sewage



- waste water treatment
- water recycling
- dumpsite



Aggressive media

- level measurement in most of acids and lyes



Input pressure range									
Nominal pressure gauge	[bar]	0.4	0.6	1	1.6	2.5	4	6	10
Level	[mH ₂ O]	4	6	10	16	25	40	60	100
Overpressure	[bar]	1	2	2	4	4	10	10	20
Burst pressure ≥	[bar]	2	4	4	5	5	12	12	25

Output signal / Supply	
Standard	2-wire: 4 ... 20 mA / V _S = 8 ... 32 V _{DC}

Performance	
Accuracy ¹	≤ ± 0.5 % FSO
Permissible load	R _{max} = [(V _S - V _{S min}) / 0.02 A] Ω
Influence effects	supply: 0.05 % FSO / 10 V load: 0.05 % FSO / kΩ
Long term stability	≤ ± 0.1 % FSO / year
Response time	< 10 msec

¹ accuracy according to IEC 60770 – limit point adjustment (non-linearity, hysteresis, repeatability)

Thermal effects (Offset and Span)	
Thermal error	≤ ± 0.2 % FSO / 10 K in compensated range -25 ... 70 °C

Permissible temperatures	
Permissible temperatures	medium: 0 ... 50 °C storage: -10 ... 50 °C

Electrical protection ²	
Short-circuit protection	permanent
Reverse polarity protection	no damage, but also no function
Electromagnetic compatibility	emission and immunity according to EN 61326

² additional external overvoltage protection unit in terminal box KL 1 or KL 2 with atmospheric pressure reference available on request

Electrical connection	
Cable with sheath material ³	PVC (0 ... 50 °C) grey PUR (0 ... 50 °C) black FEP (0 ... 50 °C) black

³ cable with integrated air tube for atmospheric pressure reference

Materials (media wetted)	
Housing	PVC grey
Seals	FKM / EPDM / FFKM
Diaphragm	ceramics Al ₂ O ₃ 96 %

Miscellaneous	
Option SIL 2 application	according to IEC 61508 / IEC 61511
Connecting cables (by factory)	cable capacitance: signal line/shield also signal line/signal line: 160 pF/m cable inductance: signal line/shield also signal line/signal line: 1 μH/m
Current consumption	max. 25 mA
Weight	approx. 200 g (without cable)
Ingress protection	IP 68
CE-conformity	EMC Directive: 2004/108/EC

Wiring diagram

2-wire-system (current)

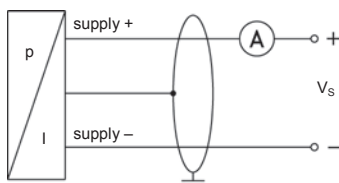

Pin configuration	
Electrical connection	cable colours (DIN 47100)
Supply +	wh (white)
Supply -	bn (brown)
Shield	gn/ye (green / yellow)

Dimensions (in mm)

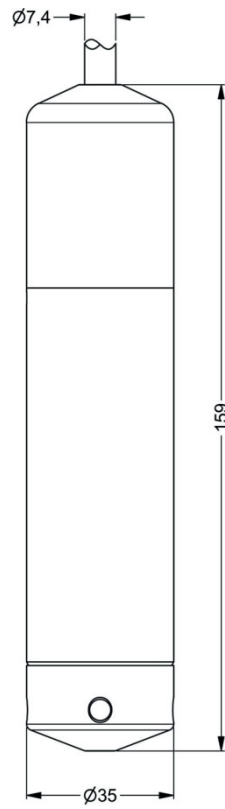



LMK 809

Plastic Probe For Aggressive Media

High Purity Ceramic Sensor

accuracy according to IEC 60770:
standard: 0.35 % FSO
option: 0.25 % FSO

Nominal pressure

from 0 ... 0.4 mH₂O up to 0 ... 100 mH₂O

Output signals

2-wire: 4 ... 20 mA
3-wire: 0 ... 10 V
others on request

Special characteristics

- ▶ diameter 45 mm
- ▶ chemical resistance
- ▶ high overpressure resistance
- ▶ especially for tank level measurement of viscous and aggressive media
- ▶ diaphragm 99.9 % Al₂O₃
- ▶ housing material PP or PVDF

Optional versions

- ▶ different kinds of cable and seal materials
- ▶ prepared for mounting with pipe

The plastic submersible probe LMK 809 is designed for continuous level measurement in waste water or in most of aggressive media. Basic element is a capacitiv ceramic sensor.

Basic element of the plastic probe is the flush mounted ceramic sensor, which makes cleaning easier when solid parts of the medium deposit on it. Different cable and seal materials are available in order to achieve maximum media compatibility.

Preferred areas of use are



Sewage

waste water treatment
water recycling
dumpsite



Aggressive media

level measurement in most of acids and lyes



Input pressure range														
Nominal pressure gauge	[bar]	0.04	0.06	0.1	0.16	0.25	0.4	0.6	1	1.6	2.5	4	6	10
Level	[mH ₂ O]	0.4	0.6	1	1.6	2.5	4	6	10	16	25	40	60	100
Overpressure	[bar]	2	2	4	4	6	6	8	8	15	25	25	35	35

Output signal / Supply	
Standard	2-wire: 4 ... 20 mA / V _S = 9 ... 32 V _{DC}
Option 3-wire	3-wire: 0 ... 10 V / V _S = 12.5 ... 32 V _{DC}

Performance	
Accuracy ¹	standard: ≤ ± 0.35 % FSO option: ≤ ± 0.25 % FSO
Permissible load	R _{max} = [(V _S - V _{S min}) / 0.02 A] Ω
Influence effects	supply: 0.05 % FSO / 10 V load: 0.05 % FSO / kΩ
Long term stability	≤ ± 0.1 % FSO / year
Turn-on time	700 msec
Mean response time	< 200 msec
Max. response time	380 msec
	measuring rate: 5/sec

¹ accuracy according to IEC 60770 – limit point adjustment (non-linearity, hysteresis, repeatability)

Thermal effects (Offset and Span)	
Thermal error	≤ ± 0.1 % FSO / 10 K in compensated range 0 ... 70 °C

Permissible temperatures	
Permissible temperatures	medium: -25 ... 100 °C electronic / environment: -25 ... 100 °C storage: -25 ... 100 °C

Electrical protection ²	
Short-circuit protection	permanent
Reverse polarity protection	no damage, but also no function
Electromagnetic compatibility	emission and immunity according to EN 61326

² additional external overvoltage protection unit in terminal box KL 1 or KL 2 with atmospheric pressure reference available on request

Electrical connection	
Cable with sheath material ³	PUR (-25 ... 70 °C) black FEP (-25 ... 70 °C) black TPE (-25 ... 100 °C) blue

³ cable with integrated air tube for atmospheric pressure reference

Materials (media wetted)	
Housing	standard: PP option: PVDF
Seals	FKM / EPDM / FFKM
Diaphragm	ceramics Al ₂ O ₃ 99.9 %

Miscellaneous	
Connecting cables (by factory)	cable capacitance: signal line/shield also signal line/signal line: 160 pF/m cable inductance: signal line/shield also signal line/signal line: 1 μH/m
Current consumption	max. 21 mA
Weight	approx. 320 g (without cable)
Ingress protection	IP 68
CE-conformity	EMC Directive: 2004/108/EC

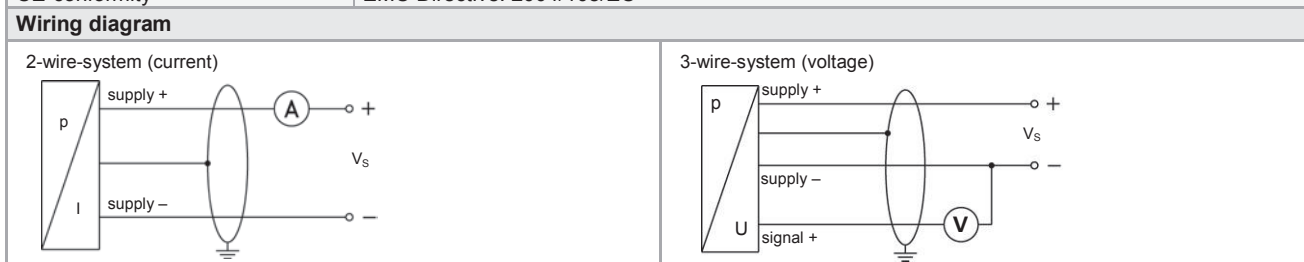

Pin configuration	
Electrical connection	cable colours (DIN 47100)
Supply +	wh (white)
Supply -	bn (brown)
Signal + (only for 3-wire)	gn (green)
Shield	gn/ye (green / yellow)

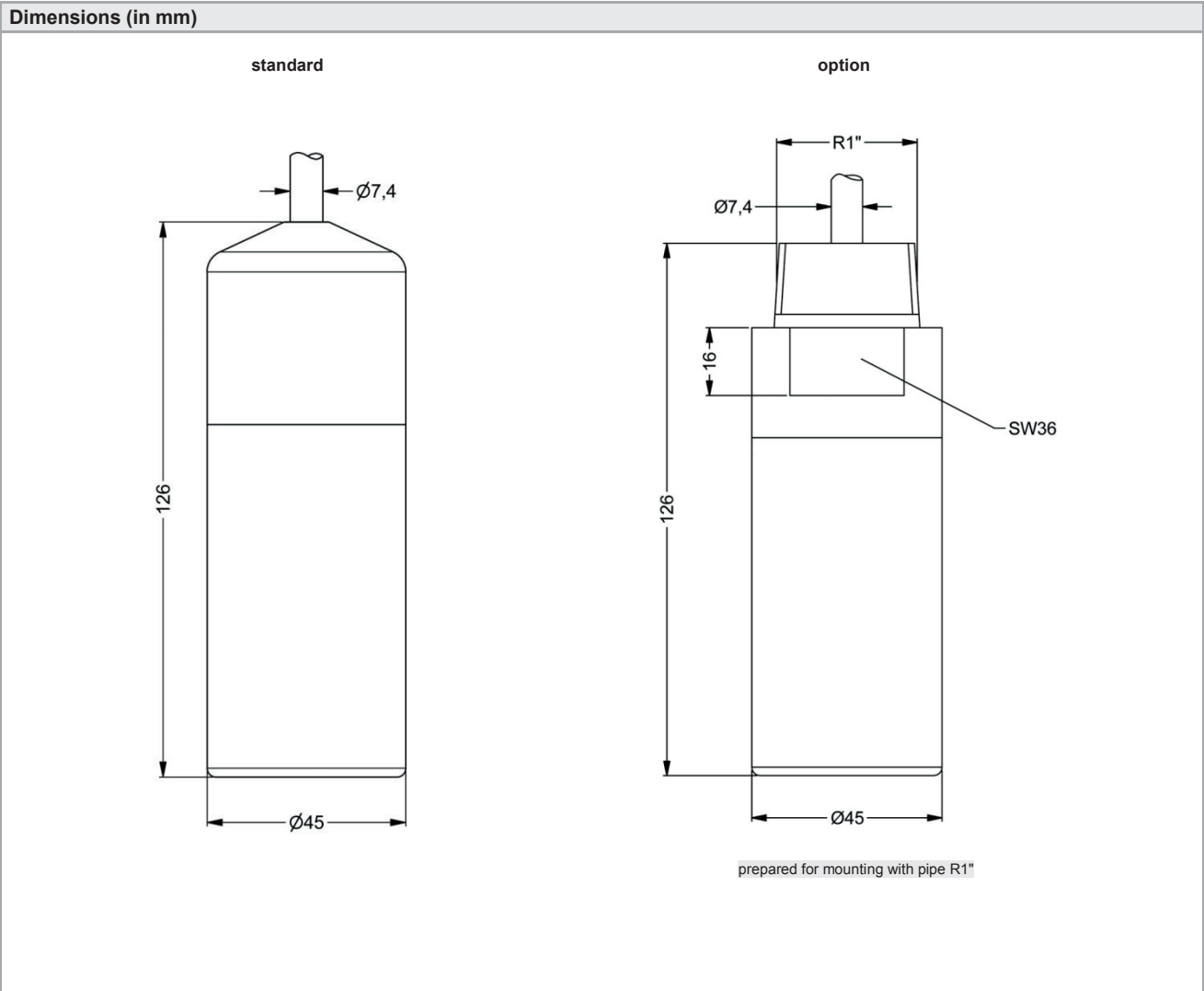



LMK 858

Separable Plastic Submersible Probe

Ceramic Sensor

accuracy according to IEC 60770:
 standard: 0.35 % FSO
 option: 0.25 % FSO

Nominal pressure

from 0 ... 40 cmH₂O up to 0 ... 100 mH₂O

Output signals

2-wire: 4 ... 20 mA
 3-wire: 0 ... 10 V
 others on request

Special characteristics

- ▶ diameter 45 mm
- ▶ cable and probe separable
- ▶ chemical resistance
- ▶ housing PVC

Optional versions

- ▶ cable protection via PVC pipe
- ▶ diaphragm 99.9 % Al₂O₃
- ▶ different kinds of cable
- ▶ different kinds of seal materials

The separable plastic submersible probe LMK 858 is designed for level measurement in most aggressive media. Usage in more viscous media as for example sludge is possible because of the semi-flush diaphragm.

In order to facilitate stock-keeping and maintenance the transmitter head is plugged to the cable assembly with a connector and can be changed easily.

Preferred areas of use are

Sewage



waste water treatment
 water recycling
 dumpsite

Aggressive media



level measurement in most of acids and lyes



Pin configuration			
Electrical connection	Binder series 723 ⁴ (5-pin)		cable colours (DIN 47100)
	2 - wire	3 - wire	
Supply +	3	3	wh (white)
Supply -	1	4	bn (brown)
Signal + (only for 3-wire)	-	1	gn (green)
Shield	5	5	gn/ye (green / yellow)

⁴ in separated version

Dimensions (in mm)

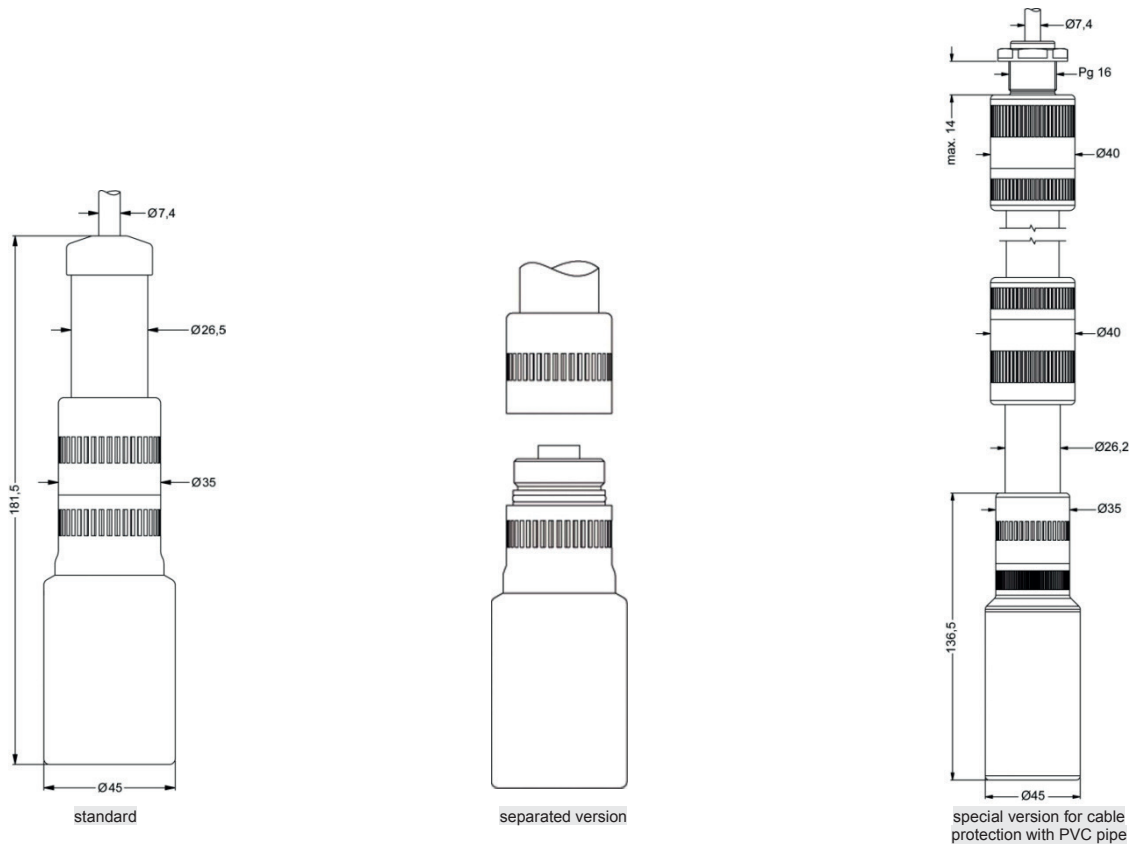



LMP 331

Screw-In Transmitter

Stainless Steel Sensor

accuracy according to IEC 60770:
standard: 0.35 % FSO
option: 0.25 % / 0.1 % FSO

Nominal pressure

from 0 ... 100 mbar up to 0 ... 40 bar

Output signals

2-wire: 4 ... 20 mA

3-wire: 0 ... 20 mA / 0 ... 10 V

others on request

Special characteristics

- ▶ pressure port G 3/4" flush
- ▶ excellent accuracy
- ▶ small thermal effect
- ▶ excellent long term stability

Optional versions

- ▶ accuracy 0.1% FSO IEC 60770
- ▶ IS-version: Ex ia = intrinsically safe for gases and dusts
- ▶ SIL 2 application according to IEC 61508 / IEC 61511
- ▶ different electrical connections
- ▶ customer specific versions
e. g. special pressure ranges

The screw-in transmitter LMP 331 has been designed for continuous level measurement and is characterized by an excellent performance and a robust construction. The modular construction allows the user the highest possible flexibility in the adaptation of LMP 331.

Optional features like e.g. an intrinsically safe version or a functionally safe version (SIL 2) increase the advantages when launching and realizing projects for plants and systems.

Preferred areas of use are



Plant and Machine Engineering



Energy Industry



Environmental Engineering
(water – sewage – recycling)



Input pressure range																	
Nominal pressure gauge	[bar]	0.10	0.16	0.25	0.40	0.60	1	1.6	2.5	4	6	10	16	25	40		
Level	[mH ₂ O]	1	1.6	2.5	4	6	10	16	25	40	60	100	160	250	400		
Overpressure	[bar]	0.5	1	1	2	5	5	10	10	20	40	40	80	80	105		
Burst pressure ≥	[bar]	1.5	1.5	1.5	3	7.5	7.5	15	15	25	50	50	120	120	210		
Vacuum resistance		P _N ≥ 1 bar: unlimited vacuum resistance P _N < 1 bar: on request															
Output signal / Supply																	
Standard		2-wire: 4 ... 20 mA / V _S = 8 ... 32 V _{DC}															
Option IS-version		2-wire: 4 ... 20 mA / V _S = 10 ... 28 V _{DC}															
Options 3-wire		3-wire: 0 ... 20 mA / V _S = 14 ... 30 V _{DC}										0 ... 10 V / V _S = 14 ... 30 V _{DC}					
Performance																	
Accuracy ¹		standard: nominal pressure < 0.4 bar: ≤ ± 0.5 % FSO nominal pressure ≥ 0.4 bar: ≤ ± 0.35 % FSO option 1: nominal pressure ≥ 0.4 bar: ≤ ± 0.25 % FSO option 2: for all nominal pressures: ≤ ± 0.1 % FSO															
Permissible load		current 2-wire: R _{max} = [(V _S - V _{S min}) / 0.02 A] Ω current 3-wire: R _{max} = 500 Ω voltage 3-wire: R _{min} = 10 kΩ															
Influence effects		supply: 0.05 % FSO / 10 V										load: 0.05 % FSO / kΩ					
Long term stability		≤ ± 0.1 % FSO / year															
Response time		2-Leiter: ≤ 10 msec 3-Leiter: ≤ 3 msec															
¹ accuracy according to IEC 60770 – limit point adjustment (non-linearity, hysteresis, repeatability)																	
Thermal effects (Offset and Span)																	
Nominal pressure P _N	[bar]	≤ 0.40										> 0.40					
Tolerance band	[% FSO]	≤ ± 1										≤ ± 0.75					
in compensated range	[°C]	0 ... 70										-20 ... 85					
Permissible temperatures																	
Permissible temperatures		medium: -40 ... 125 °C				electronics / environment: -40 ... 85 °C				storage: -40 ... 100 °C							
Electrical protection																	
Short-circuit protection		permanent															
Reverse polarity protection		no damage, but also no function															
Electromagnetic compatibility		emission and immunity according to EN 61326															
Mechanical stability																	
Vibration		10 g RMS (25 ... 2000 Hz)				according to DIN EN 60068-2-6											
Shock		500 g / 1 msec				according to DIN EN 60068-2-27											
Explosion protection (only for 4 ... 20 mA / 2-wire)																	
Approvals DX19-LMP 331		IBExU 10 ATEX 1068 X / IECEx IBE 12.0027X zone 0: II 1G Ex ia IIC T4 Ga zone 20: II 1D Ex ia IIIC T 85°C Da															
Safety technical maximum values		U _i = 28 V, I _i = 93 mA, P _i = 660 mW, C _i ≈ 0nF, L _i ≈ 0 μH, the supply connections have an inner capacity of max. 27 nF opposite the housing															
Permissible temperature for medium		in zone 0: -20 ... 60 °C with p _{atm} 0.8 bar bis 1.1 bar in zone 1 or higher: -20 ... 70 °C															
Connecting cables (by factory)		cable capacitance: signal line/shield also signal line / signal line: 160 pF/m cable inductance: signal line /shield also signal line / signal line: 1 μH/m															
Materials																	
Pressure port		stainless steel 1.4404 (316L)															
Housing		stainless steel 1.4404 (316L)															
Seals		standard: FKM option: EPDM, NBR										others on request					
Diaphragm		stainless steel 1.4435 (316L)															
Media wetted parts		pressure port, seals, diaphragm															
Miscellaneous																	
Optionally SIL ² 2 application		according to IEC 61508 / IEC 61511															
Current consumption		signal output current: max. 25 mA										signal output voltage: max. 7 mA					
Weight		approx. 200 g															
Installation position		any ³															
Operational life		> 100 x 10 ⁶ cycles															
CE-conformity		EMC Directive: 2004/108/EC															
ATEX Directive		94/4/EG															
² only for 4...20mA / 2-wire, not in combination with the accuracy 0.1%																	
³ Pressure transmitters are calibrated in a vertical position with the pressure connection down. If this position is changed on installation there can be slight deviation in the zero point for pressure ranges P _N ≤ 1 bar.																	

Pin configuration					
Electrical connections	ISO 4400	Binder 723 (5-pin)	M12x1 / metal (4-pin)	field housing	cable colours (DIN 47100)
Supply +	1	3	1	IN +	wh (white)
Supply -	2	4	2	IN -	bn (brown)
Signal + (only for 3-wire)	3	1	3	OUT +	gn (green)
Shield	ground pin	5	4		ye/gn (yellow/green)

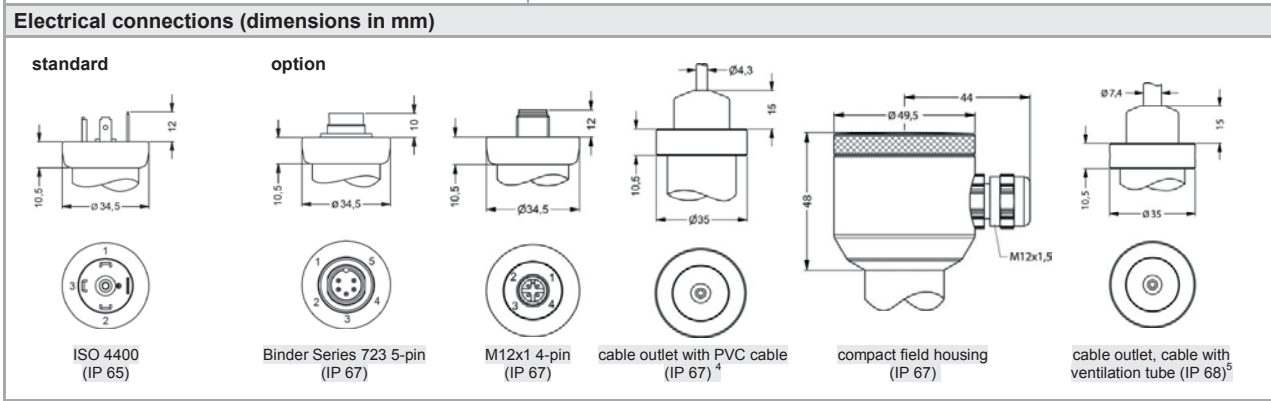
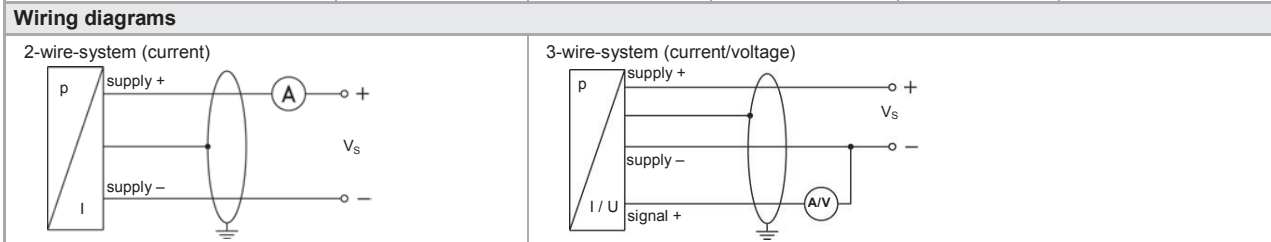

⁴ standard: 2 m PVC cable (without ventilation tube, permissible temperature: -5 ... 70 °C)
⁵ different cable types and lengths available, permissible temperature depends on kind of cable

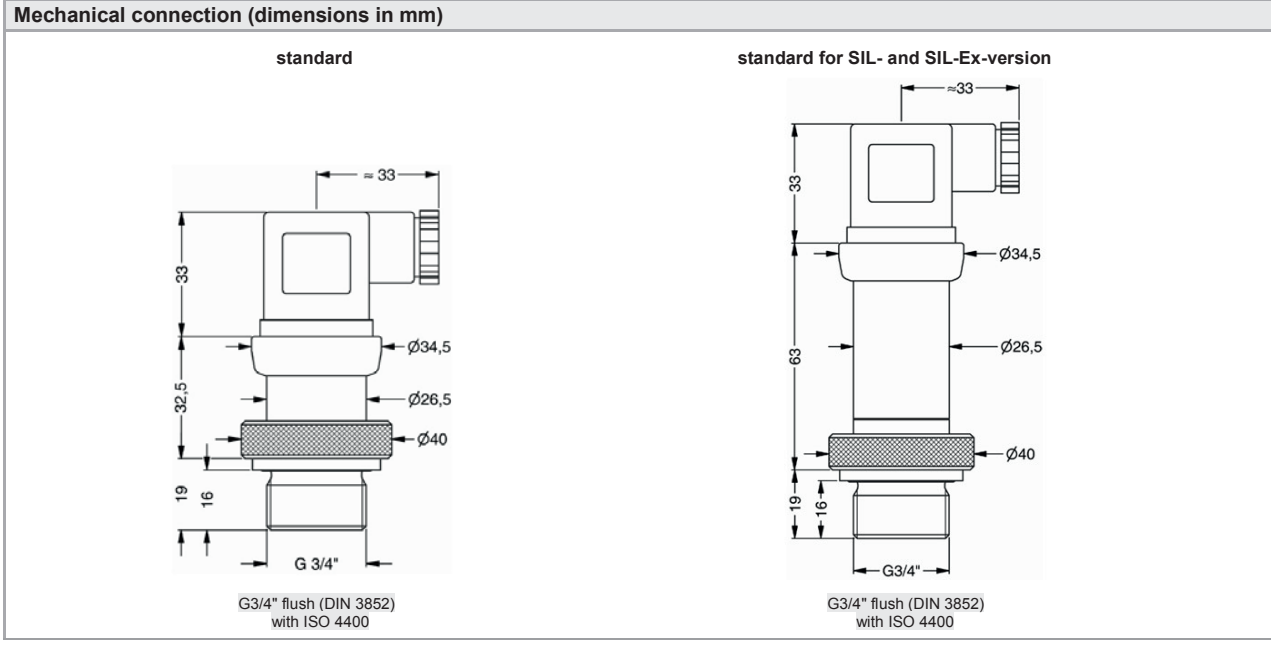



LMK 331

Screw-In Transmitter

Ceramic Sensor

accuracy according to IEC 60770:
0.5 % FSO

Nominal pressure

from 0 ... 400 mbar up to 0 ... 60 bar

Output signals

2-wire: 4 ... 20 mA

3-wire: 0 ... 20 mA / 0 ... 10 V

others on request

Special characteristics

- ▶ pressure port G 3/4" flush for pasty and impurified media
- ▶ pressure port PVDF for aggressive media





Optional versions

- ▶ IS-version (only for 4 ... 20mA / 2-wire):
Ex ia = intrinsically safe for gases and dusts
- ▶ SIL 2 application according to IEC 61508 / IEC 61511
- ▶ customer specific versions

The screw-in transmitter LMK 331 has been especially designed for level and process measurement and is suitable for pressure measurement of liquids, oils and gases. Usage in more viscous or polluted media is possible because of the semi-flush pressure sensor.

For the usage in aggressive media we recommend the version with PVDF pressure port. Additional features like e.g. an intrinsically safe version or a functionally safe version (SIL 2) complete the range of possibilities.

Preferred areas of use are

-  Plant and Machine Engineering
-  Energy Industry
-  Environmental Engineering
(water – sewage – recycling)
-  Medical Technology



Input pressure range													
Nominal pressure gauge	[bar]	0.4	0.6	1	1.6	2.5	4	6	10	16	25	40 ¹	60 ¹
Level	[mH ₂ O]	4	6	10	16	25	40	60	100	160	250	400	600
Overpressure	[bar]	1	2	2	4	4	10	20	20	40	100	100	200
Burst pressure	[bar]	2	4	4	5	5	12	25	25	50	120	120	250
Vacuum resistance	[bar]	P _N ≥ 1 bar: unlimited vacuum resistance P _N < 1 bar: on request											

¹ only possible with stainless steel pressure port

Output signal / Supply	
Standard	2-wire: 4 ... 20 mA / V _S = 8 ... 32 V _{DC}
Option IS-protection ²	2-wire: 4 ... 20 mA / V _S = 10 ... 28 V _{DC}
Optionen 3-wire	3-wire: 0 ... 20 mA / V _S = 14 ... 30 V _{DC} 0 ... 10 V / V _S = 14 ... 30 V _{DC}

² IS-protection not possible with plastic pressure port

Performance	
Accuracy ³	≤ ± 0.5 % FSO
Permissible load	current 2-wire: R _{max} = [(V _S - V _{Smin}) / 0.02 A] Ω current 3-wire: R _{max} = 500 Ω voltage 3-wire: R _{min} = 10 kΩ
Influence effects	supply: 0.05 % FSO / 10 V load: 0.05 % FSO / kΩ
Response time	2-wire: ≤ 10 msec 3-wire: ≤ 3 msec

³ accuracy according to IEC 60770 – limit point adjustment (non-linearity, hysteresis, repeatability)

Thermal effects (Offset and Span) / Permissible Temperatures	
Thermal error	≤ ± 0.2 % FSO / 10 K
in compensated range	-25 ... 85 °C
Permissible temperatures ⁴	medium: -40 ... 125 °C storage: -40 ... 100 °C electronics / environment: -40 ... 85 °C

⁴ for pressure port of PVC the minimum permissible temperature is -30 °C

Electrical protection	
Short-circuit protection	permanent
Reverse polarity protection	no damage, but also no function
Electromagnetic compatibility	emission and immunity according to EN 61326

Mechanical stability	
Vibration	10 g RMS (25 ... 2000 Hz) according to DIN EN 60068-2-6
Shock	500 g / 1 msec according to DIN EN 60068-2-27

Materials			
Pressure port / housing	standard:	pressure port	housing
	options for P _N ≤ 25 bar:	stainless steel 1.4404 (316L) PVDF	stainless steel 1.4404 (316L) PVDF
Option compact field housing	stainless steel 1.4305 with cable gland brass nickel plated others on request		
Seals	standard: FKM options: EPDM, NBR, others on request		
Diaphragm	ceramics Al ₂ O ₃ 96 %		
Media wetted parts	pressure port, seals, diaphragm		

Explosion protection (only for 4 ... 20 mA / 2-wire)	
Approval DX19-LMK 331 only for stainless steel pressure port	IBExU 10 ATEX 1068 X / IECEx IBE 12.0027X zone 0: II 1G Ex ia IIC T4 Ga zone 20: II 1D Ex ia IIIC T 85°C Da
Safety technical maximum values	U _i = 28 V, I _i = 93 mA, P _i = 660 mW, C _i ≈ 0 nF, L _i ≈ 0 μH, the supply connections have an inner capacity of max. 27 nF to the housing
Permissible temperatures for environment	in Zone 0: -20 ... 60 °C with p _{atm} 0.8 bar up to 1.1 bar in Zone 1 or higher: -25 ... 70 °C
Connecting cables (by factory)	cable capacitance: signal line/shield also signal line / signal line: 160 pF/m cable inductance: signal line /shield also signal line / signal line: 1 μH/m

Miscellaneous	
Option SIL ⁵ 2 application	according to IEC 61508 / IEC 61511
Current consumption	signal output current: max. 25 mA signal output voltage: max. 7 mA
Weight	approx. 150 g
Installation position	any
Operational life	> 100 x 10 ⁶ pressure cycles
CE-conformity	EMC Directive: 2004/108/EC
ATEX Directive	94/4/EG

⁵ only for 4...20mA / 2-wire

Wiring diagrams					
2-wire-system (current)		3-wire-system (current / voltage)			
Pin configuration					
Electrical connections	ISO 4400	Binder 723 (5-pin)	M12x1 / metal (4-pin)	cable colours (DIN 47100)	
Supply +	1	3	1	wh (white)	
Supply -	2	4	2	bn (brown)	
Signal + (only for 3-wire)	3	1	3	gn (green)	
Shield	ground contact	5	4	gn/ye (green / yellow)	
Electrical connections (dimensions in mm)					
standard ISO 4400 (IP 65)	option Binder Series 723 5-pin (IP 67)	 M12x1 4-pin (IP 67)	 cable outlet with PVC cable (IP 67) ⁶	 compact field housing (IP 67)	 cable outlet, cable with ventilation tube (IP 68) ⁷
⇒ universal stainless steel housing 1.4404 with cable gland M20x1.5 (ordering code 880) and other versions on request					
⁶ standard: 2 m PVC-cable without ventilation tube (permissible temperature: -5 ... 70°C) ⁷ different cable types and length available, permissible temperature depends on kind of cable					
Mechanical connection (dimensions in mm)					
standard G3/4" flush (DIN 3852) with ISO 4400		standard for SIL- and SIL-Ex-version G3/4" flush (DIN 3852) with ISO 4400			

LMK 331



Pressure																					
	gauge in bar	4	6	0																	
	gauge in mH ₂ O	4	6	1																	
Input																					
	[mH ₂ O]																				
	[bar]																				
	4.0				4	0	0	0													
	6.0				6	0	0	0													
	10				1	0	0	1													
	16				1	6	0	1													
	25				2	5	0	1													
	40				4	0	0	1													
	60				6	0	0	1													
	100				1	0	0	2													
	160				1	6	0	2													
	250				2	5	0	2													
	400				4	0	0	2													
	600				6	0	0	2													
	customer				9	9	9	9												consult	
Analogue output																					
	4 ... 20 mA / 2-wire							1													
	0 ... 20 mA / 3-wire							2													
	0 ... 10 V / 3-wire							3													
	Intrinsic safety 4 ... 20 mA / 2-wire ²							E													
	SIL2 4 ... 20 mA / 2-wire							1S													
	SIL2 with Intrinsic safety ²							ES													
	4 ... 20 mA / 2-wire							9													
	customer																			consult	
Accuracy																					
	0.5 %							5													
	customer							9												consult	
Electrical connection																					
	Male and female plug ISO 4400							1	0	0											
	Male plug Binder series 723 (5-pin)							2	0	0											
	Cable outlet with PVC cable ³							T	A	0											
	Cable outlet with cable							T	R	0											
	Male plug M12x1 (4-pin) / metal							M	1	0											
	compact field housing							8	5	0											
	stainless steel 1.4305							9	9	9											
	customer																			consult	
Mechanical connection																					
	G3/4" DIN 3852 with									K	0	0									
	flush sensor																				
	customer									9	9	9								consult	
Seals																					
	FKM												1								
	NBR												5								
	EPDM												3								
	customer												9							consult	
Pressure port																					
	Stainless steel 1.4404 (316L)													1							
	for P _N ≤ 25 bar													B							
	PVDF ⁴													9							
	customer																			consult	
Diaphragm																					
	Ceramics Al ₂ O ₃ 96%														2						
	customer														9					consult	
Special version																					
	standard																		0	0	0
	customer																		9	9	9
																					consult

¹ only possible for pressure port of stainless steel

² Ex-protection not possible with plastic pressure port

³ standard: 2 m PVC cable without ventilation tube (permissible temperature: -5 ... 70 °C)

⁴ min. permissible temperature -30 °C



LMK 351

Screw-in Transmitter

Ceramic Sensor

accuracy according to IEC 60770:
standard: 0.35% FSO
option: 0.25% FSO

Nominal pressure

from 0 ... 40 mbar up to 0 ... 20 bar

Output signal

2-wire: 4 ... 20 mA
3-wire: 0 ... 20 mA / 0 ... 10 V
others on request

Product characteristics

- ▶ pressure port PVDF-version for aggressive media
- ▶ pressure port G 1 ½" for pasty and polluted media



Optional versions

- ▶ IS-version
Ex ia = intrinsically safe for gases and dusts
- ▶ diaphragm 99.9 % Al₂O₃
- ▶ customer specific versions



The screw-in transmitter LMK 351 has been designed for measuring small system pressure and level measurement in container. The LMK 351 is based on an own-developed capacitive ceramic sensor element. Usage in viscous and pasty media is possible because of the flush mounted sensor.

For the usage in aggressive media a pressure port in PVDF and the diaphragm in Al₂O₃ 99.9 % is available. An intrinsically safe version complete the range of possibilities.

Preferred areas of use are

-  Plant and Machine Engineering
-  Environmental Engineering
(water – sewage – recycling)

Preferred used for

-  Fuel and Oil
-  Viscous and Pasty Media



Pressure ranges																
Nominal pressure	[bar]	0.04	0.06	0.1	0.16	0.25	0.4	0.6	1	1.6	2.5	4	6	10	16	20
Level	[mH ₂ O]	0.4	0.6	1	1.6	2.5	4	6	10	16	25	40	60	100	160	200
Overpressure	[bar]	2	2	4	4	6	6	8	8	15	25	25	35	35	45	45
Low pressure	[bar]	-0.2		-0.3		-0.5			-1							

Output signal / Supply	
Standard	2-wire: 4 ... 20 mA / V _S = 9 ... 32 V _{DC}
Option Ex-version	2-wire: 4 ... 20 mA / V _S = 14 ... 28 V _{DC}
Option 3-wire	3-wire: 0 ... 10 V / V _S = 12.5 ... 32 V _{DC}

Performance	
Accuracy ¹	standard: ≤ ± 0.35 % FSO option: ≤ ± 0.25 % FSO
Permissible load	current 2-wire: R _{max} = [(V _S - V _{S min}) / 0.02 A] Ω voltage 3-wire: R _{min} = 10 kΩ
Influence effects	supply: 0.05 % FSO / 10 V load: 0.05 % FSO / kΩ
Long term stability	≤ ± 0.1 % FSO / year
Turn-on time	700 msec
Mean measuring time	5/sec
Response time	mean response time: ≤ 200 msec max. response time: 380 msec

¹ accuracy according to IEC 60770 - limit point adjustment (non-linearity, hysteresis, repeatability)

Thermal effects (Offset and Span) / -Permissible temperatures	
Tolerance band	≤ ± 0.1 % FSO / 10 K in compensated range - 20 ... 80 °C
Permissible temperatures ²	medium: -40 ... 125 °C electronics / environment: -40 ... 85 °C storage: -40 ... 100 °C

² for pressure port of PVC the minimum permissible temperature is -30 °C

Electrical protection	
Short-circuit protection	permanent
Reverse polarity protection	no damage, but also no function
Electromagnetic compatibility	emission and immunity according to EN 61326

Mechanical stability	
Vibration	10 g RMS (20 ... 2000 Hz) according to DIN EN 60068-2-6
Shock	100 g / 1 msec according to DIN EN 60068-2-27

Materials (media wetted)	
Pressure port	standard: stainless steel 1.4404 (316L) option: PVDF
Housing	standard: stainless steel 1.4404 (316L) option: PVDF
Seals	FKM -40 ... 125 °C FFKM -15 ... 125 °C EPDM -40 ... 125 °C
Diaphragm	standard: ceramics Al ₂ O ₃ 96 % options: ceramics Al ₂ O ₃ 99.9 %
Media wetted parts	pressure port, seals, diaphragm

IS-protection (only for 4 ... 20 mA / 2-wire)	
Approval DX14-LMK 351	IBExU05ATEX1070 X stainless steel-pressure port with male (connector): zone 0: II 1 G Ex ia IIC T4 Ga zone 20: II 1 D Ex iaD T 85 °C stainless steel-pressure port with cable: zone 0: II 1 G Ex ia IIB T4 Ga zone 20: II 1 D Ex iaD T 85 °C plastic-pressure port with male (connector): zone 0/1 ³ : II 1/2 G Ex ia IIC T4 Ga/Gb zone 20/21 ⁴ : II 1 D Ex iaD T 85 °C plastic-pressure port with cable: zone 0/1 ³ : II 1/2 G Ex ia IIB T4 Ga/Gb zone 20/21 ⁴ : II 1 D Ex iaD T 85 °C
Safety technical maximum values	U _i = 28 V, I _i = 93 mA, P _i = 660 mW, C _i = 27 nF, L _i = 5 μH
Max. permissible temperature for environment	in zone 0: -20 ... 60 °C for p _{atm} 0.8 bar up to 1.1 bar zone 1 and higher: -25 ... 70 °C
Connecting cables (by factory)	capacity: signal line / shield also signal line / signal line: 160 pF/m inductance: signal line / shield also signal line / signal line: 1 μH/m

³ The designation depends on the used pressure range. With nominal pressure ranges ≤ 60 mbar the designation is „2G“.

With nominal pressure ranges > 60 mbar and < 10 bar (see item 17 of the type-examination certificate) must be attended!

Miscellaneous	
Current consumption	signal output current: max. 21 mA signal output voltage: max. 5 mA
Weight	approx. 200 g
Installation position	any
Operational life	> 100 x 10 ⁶ loading cycles
CE-conformity	EMV-directive: 2004/108/EC
ATEX Directive	94/9/EC

Wiring diagram

2-wire-system (current)

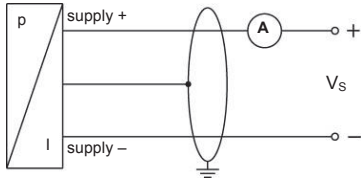

3-wire-system (current/voltage)

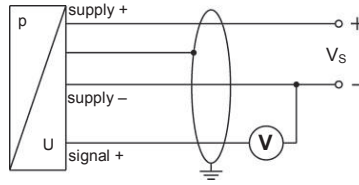

Pin configuration

Electrical connection	ISO 4400	Binder 723 (5-pin)	M12x1 (4-pin)	field housing	cable colours (DIN 47100)
Supply +	1	3	1	IN +	wh (white)
Supply -	2	4	2	IN -	bn (brown)
Signal + (only for 3-wire)	3	1	3	OUT +	gn (green)
Shield	ground pin	5	4	⏏	gn/ye (green/yellow)

Electrical connections (dimensions in mm)

standard

option

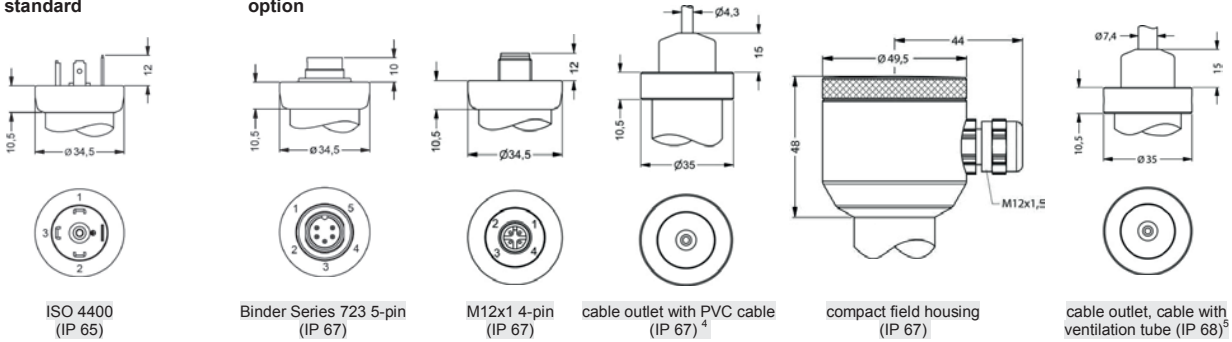

⁴ standard: 2 m PVC cable without ventilation tube (permissible temperature: -5 ... 70 °C)

⁵ different cable types and lengths available, permissible temperature depends on kind of cable

Dimensions (in mm)

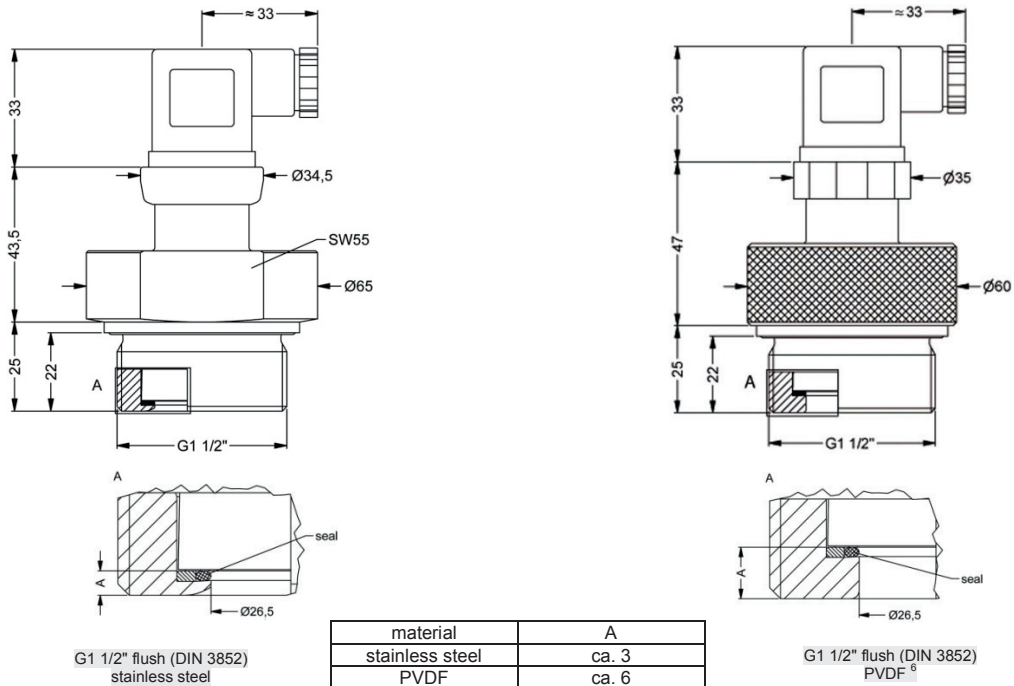

⁶ not possible in combination with compact field housing

LMK 351



Pressure																				
	in bar	4	7	0																
	in mH ₂ O	4	7	1																
Input		[mH ₂ O]	[bar]																	
	0.4	0.04		0	4	0	0													
	0.6	0.06		0	6	0	0													
	1.0	0.10		1	0	0	0													
	1.6	0.16		1	6	0	0													
	2.5	0.25		2	5	0	0													
	4.0	0.40		4	0	0	0													
	6.0	0.60		6	0	0	0													
	10	1.0		1	0	0	1													
	16	1.6		1	6	0	1													
	25	2.5		2	5	0	1													
	40	4.0		4	0	0	1													
	60	6.0		6	0	0	1													
	100	10		1	0	0	2													
	160	16		1	6	0	2													
	200	20		2	0	0	2													
	customer			9	9	9	9													consult
Output																				
	4 ... 20 mA / 2-wire							1												
	0 ... 10 V / 3-wire							3												
	Intrinsic safety 4 ... 20 mA / 2-wire							E												
	customer							9												consult
Accuracy																				
	standard	0.35 %						3												
	option	0.25 %						2												
	customer							9												consult
Electrical connection																				
	Male and female plug ISO 4400							1	0	0										
	Male plug Binder series 723 (5-pin)							2	0	0										
	Cable outlet with PVC- cable ¹							T	A	0										
	Cable outlet ²							T	R	0										
	Male plug M12x1 (4-pin) / metal compact field housing							M	1	0										
	customer							8	5	0										
								9	9	9										consult
Mechanical connection																				
	G1 1/2" DIN 3852 with flush sensor							M	0	0										
	customer							9	9	9										consult
Seals																				
	FKM							1												
	EPDM							3												
	FFKM							7												
	customer							9												consult
Pressure port																				
	Stainless steel 1.4404 (316L)							1												
	PVDF ³							B												
	customer							9												consult
Diaphragm																				
	Ceramics Al ₂ O ₃ 96%							2												
	Ceramics Al ₂ O ₃ 99.9%							C												
	customer							9												consult
Special version																				
	standard							0	0	0										
	customer							9	9	9										consult

¹ standard: 2 m PVC cable without ventilation tube (permissible temperature: -5 ... 70 °C)

² cable with ventilation tube (code TR0 = PVC cable), different cable types and lengths available, price without cable

³ not possible in combination with compact field housing; min. permissible temperature -30 °C



EP 500

Pressure Transmitter

Special application:
level measurement via air bubbling

Characteristics:

- ▶ capacitive ceramic sensor
- ▶ nominal pressure range from 0 ... 60 mbar up to 0 ... 20 bar
- ▶ output signal 4 ... 20 mA / 2-wire
- ▶ hat rail housing
- ▶ programming via integrated interface



Technical Data

Input pressure range								
Nominal pressure P _N gauge [bar]	0.06	0.16	0.4	1	2	5	10	20
Nominal pressure P _N abs. [bar]	on request							
Permissible overpressure [bar]	2	4	6	8	15	25	35	40
Permissible vacuum for P _N gauge [bar]	-0.2	-0.3	-0.5		-1			

Output signal / Supply	
Standard	2-wire: 4 ... 20 mA / V _S = 9 ... 32 V _{DC} ; V _{S Nom.} = 24 V _{DC}
Current consumption	max. 21 mA
Performance	
Accuracy ¹	IEC 60770 ² : ≤ ± 0.2 % FSO BFSL: ≤ ± 0.1 % FSO
Turn-on time	700 msec
Permissible load	R _{max} = [(V _S - V _{S min}) / 0.02 A] Ω
Long term stability	≤ ± 0.1 % FSO / year
Response time (10 ... 90 %)	120 msec – without consideration of electronic damping
Measuring rate	8/sec
¹ for nominal pressure ranges ≤ 0.4 bar the accuracy is calculated as follows: ≤ ± [0.2 + 0.04 x (nominal pressure range / adjusted range)] % FSO	
² accuracy according to IEC 60770 – limit point adjustment (non-linearity, hysteresis, repeatability)	
Thermal errors (Offset and Span)/ Permissible temperatures	
Thermal error	≤ ± (0.02 x nominal range / adjusted range) % FSO / 10 K in compensated range 0 ... 80 °C
Permissible temperatures	medium: -40 ... 125 °C electronics / environment / storage: -40 ... 85 °C

Electrical protection	
Short-circuit protection	permanent
Reverse polarity protection	no damage, but also no function
Electrical connection	
Input	terminal clamps (3-pin)
Communication connector	M12x1 (8-pin), metal
Materials	
Pressure port	standard: stainless steel 1.4301 on request: brass
Housing	version EP 500: PA6 (housing foot: PA66) version EP 500 - 500: ABS
Seals (media wetted)	FKM
Diaphragm	ceramic Al ₂ O ₃ 96 %
Media wetted parts	pressure port, seals of sensor, diaphragm
Category of the environment	
Germanischer Lloyd (GL)	C, EMC1 number of certificate: 86 482 - 09 HH
Miscellaneous	
Ingress protection	IP 00
Function display	green SMD-LED - lights by information flow through the transmitter
Installation position	any
Operational life	> 100 x 10 ⁶ pressure cycles
Weight	approx. 200 g
Adjustability	configuration via programming kit CIS 700 ³ ; following configurations are possible: - electronic damping: 0 ... 100 sec - offset: 0 ... 67 % FSO - turn down of span: max. 1:20 - configuration of pressure unit - calibration via connected pressure reference

³ programming kit has to be ordered separately (software appropriate for Windows[®] 95, 98, 2000, NT Version 4.0 or higher, and XP)

Pin configuration

Electrical connections	terminal clamps	M12x1 (8-polig), metal
Supply +1	1	-
Supply +2	-	4
Supply -	2	2
Tx	-	5
Rx	-	6
GND	-	7
NC	-	1
Shield	3	3

Wiring diagram

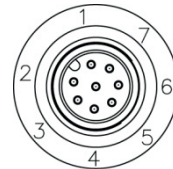
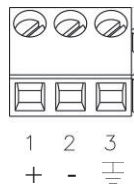
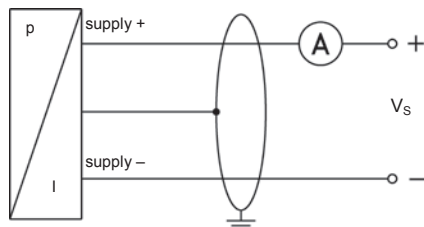

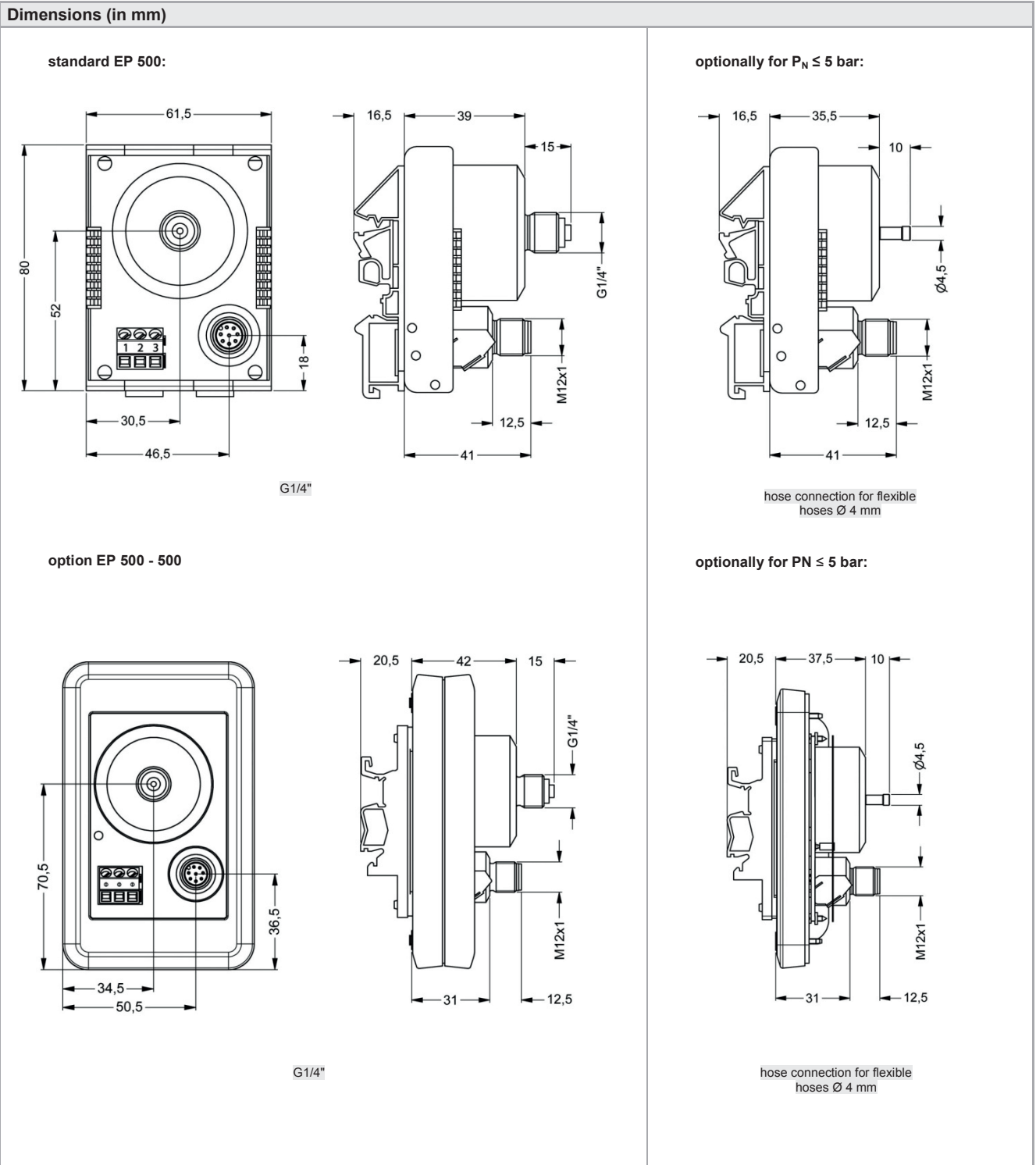

This document contains product specifications; properties are not guaranteed. Subject to change without notice.

EP 500

--	--	--	--	--	--	--	--	--	--	--	--	--	--	--	--	--	--

Pressure																						
gauge	U	P	5																			
absolute	U	P	6																		consult	
Input																						
[bar]																						
0.06				0	6	0	0															
0.16				1	6	0	0															
0.4				4	0	0	0															
1.0				1	0	0	1															
2.0				2	0	0	1															
5.0				5	0	0	1															
10				1	0	0	2															
20				2	0	0	2															
customer				9	9	9	9															consult
Output																						
4 ... 20 mA / 2-wire								1														
customer								9														consult
Accuracy																						
0.2 %										B												
customer										9												consult
Mechanical connection																						
hose connection Ø 4.5 mm ¹										Y	0	2										
G1/4" EN 837										4	0	0										
customer										9	9	9										consult
Seal																						
FKM													1									
customer													9									consult
Pressure port																						
stainless steel 1.4301 (304)															2							
brass															M							consult
customer															9							consult
Diaphragm																						
ceramics Al ₂ O ₃ 96%																2						
customer																9						consult
Special version																						
standard																		0	0	0		
option																		5	0	0		consult
customer																		9	9	9		consult

¹ hose connection only up to 5 bar



KL 1

Terminal Box

Aluminium

Product characteristics

- ▶ aluminium die cast case
- ▶ for connecting 2-wire submersible transmitters
- ▶ integrated pressure balance item
- ▶ 2 signal lines

Optional versions

- ▶ overvoltage protection with nominal discharge current of 10 kA
- ▶ Pt 100 temperature sensor for submersible pressure transmitters with built in Pt 100 sensor

The terminal box KL 1 is intended for the professional electrical connection of 2-wire transmitters.

It offers integrated atmospheric pressure compensation. Optionally with overvoltage protection and Pt 100 temperature sensor for BD|SENSORS devices.

The terminal box KL 1 is equipped with a pressure balance item for equalization of atmospheric reference, therefore a cable without ventilation tube can be used on the supply side.

Vertical terminal clamps enable easy connection of cables inside. The terminal box has to be mounted with two fastening screws.



General specifications	
Number of signal lines	2-wire (4 ... 20 mA)
Housing	aluminium die cast case, grey powder-coating
Ingress protection	IP 66
Cable entries	cable gland M16x1.5 Polyamide, seals NBR, IP 68, diameter range: standard 5 ... 10 mm others on request
Atmospheric pressure compensation	pressure balance item with PTFE filter
Terminal clamps	vertical clamps for stranded and solid wires up to 2.5 mm ²
Weight	approx. 550 g
Optional overvoltage protection	
Series resistance	10 Ω for each wire
Nominal discharge current	10 kA (8/20 μs)
Max. rated current	30 mA
Optional Pt 100 temperature sensor ¹	
Temperature range	standard: 0 ... 70 °C option: T _{min} ... T _{max} can be in range from -40 °C up to 400 °C
Connection temperature sensor	3-wire
Output signal / Supply	2-wire: 4 ... 20 mA / V _S = 12 ... 34 V _{DC}
Accuracy	< 0.15 %
Linearity	< 0.1 %
Thermal effects	< 0.01 % / K

¹ only necessary if the transmitter is equipped with a Pt 100 temperature sensor

Wiring diagram

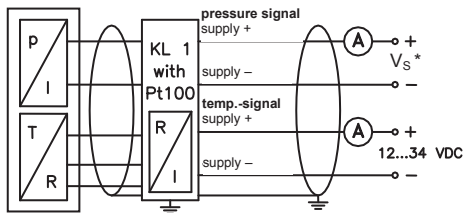

The ground wires of all components have to be connected!

* The supply V_S has to be chosen according to needs of the used transmitter.

Dimensions (in mm)

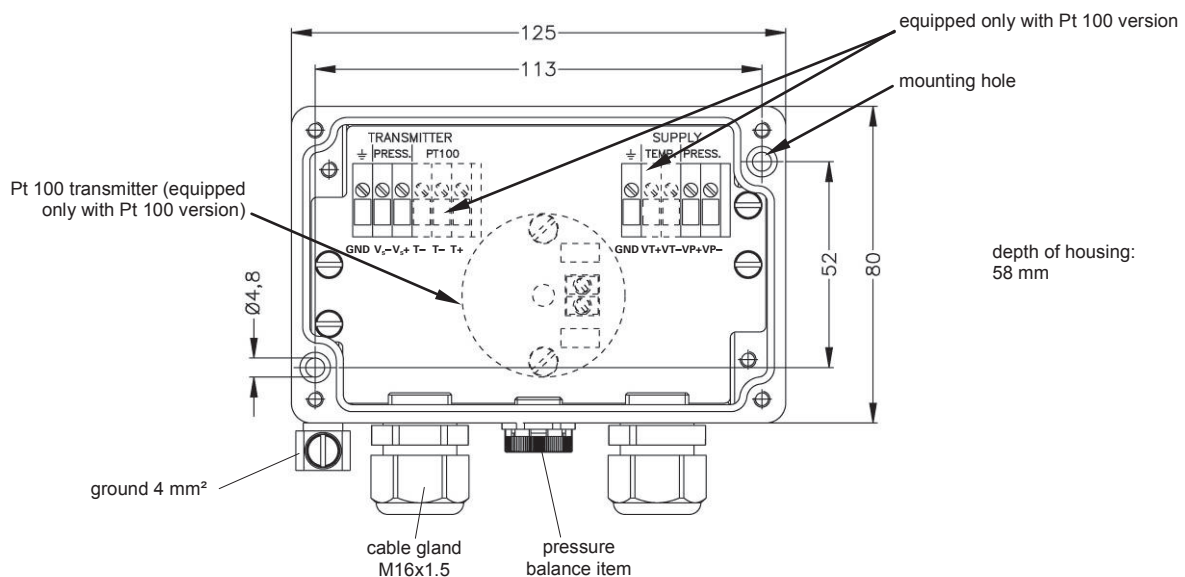

KL 1

Ordering code

KL 1 - ZB.601 -

--	--	--

 -

--	--	--

Version							
	standard	1	0	0			
	over voltage protection	1	0	1			
	thermo element Pt 100	1	T	0			
	thermo element Pt 100 and over voltage protection ¹	1	T	1			
Special version							
	standard				0	0	0
	customer				9	9	9

consult

¹ only necessary if the submersible transmitter is equipped with a Pt 100 temperature sensor



KL 2

Terminal Box

Plastics

Product characteristics

- ▶ cost-efficient ABS case
- ▶ for connecting 2-wire submersible transmitters
- ▶ integrated pressure balance item
- ▶ 2 signal lines

Optional versions

- ▶ overvoltage protection
- ▶ HART® connection

The terminal box KL 2 is intended for the professional electrical connection of submersible level transmitters. Thus, it is a cost-effective alternative to our well proven aluminium terminal box KL 1.

A pressure balance item is responsible for the compensation of atmospheric pressure variations. On the supply side a cable without ventilation tube can be used.

Vertical terminal clamps enable easy connection of cables inside the case.

The KL 2 with optional overvoltage protection is additionally equipped with surge arresters with a nominal discharge current of 10 kA.

As a further option the KL 2 is available with a HART® connection.



General specifications	
Number of signal lines	2-wire (4 ... 20 mA)
Housing material	plastic ABS, grey
Ingress protection	IP 66
Cable entries	cable gland M16x1.5 Polyamide, seals NBR, IP 68, diameter range: standard 5 ... 10 mm others on request
Atmospheric pressure compensation	pressure balance item with PTFE filter
Terminal clamps	vertical clamps for stranded and solid wires up to 2.5 mm ²
Weight	approx. 220 g
Optional overvoltage protection	
Series resistance	10 Ω for each wire
Nominal discharge current	10 kA (8/20 μs)
Max. rated current	30 mA

Optional HART® connection	
Connections	terminal clamp connection

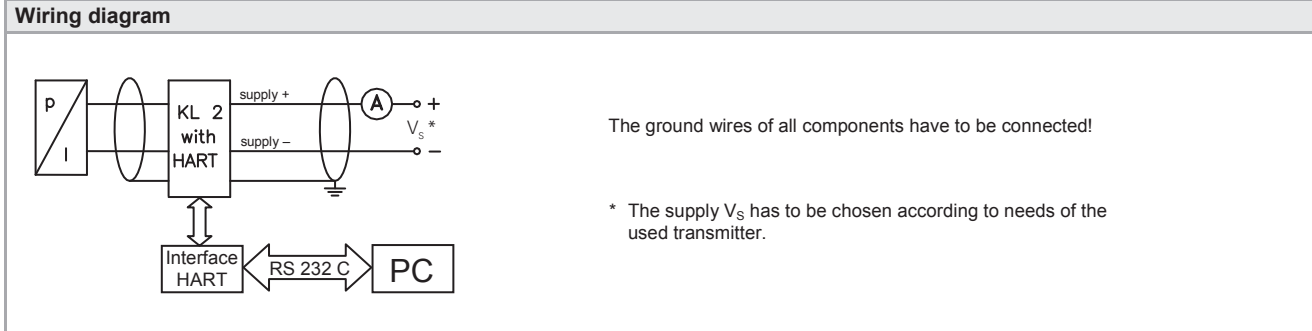

Dimensions (in mm)

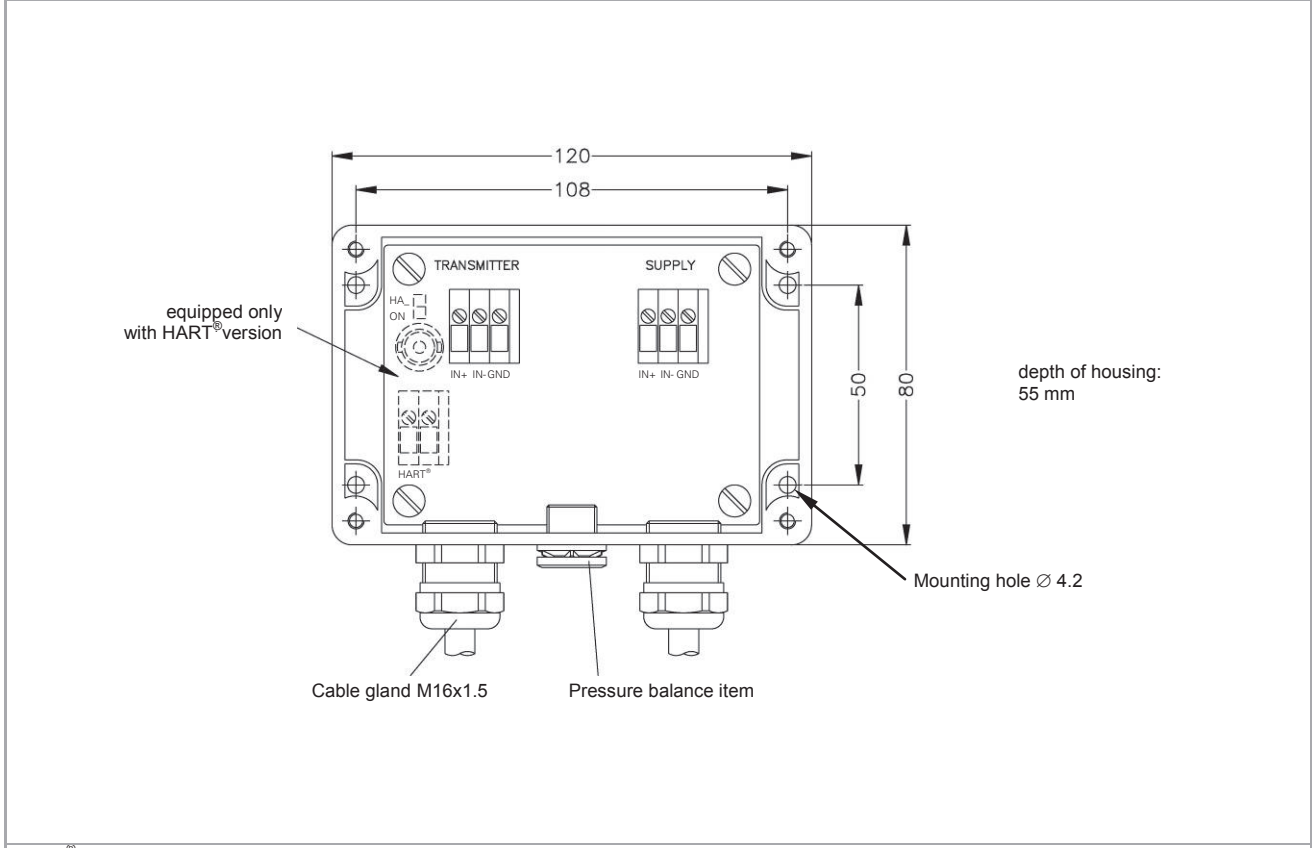

HART® is a registered trade mark of HART Communication Foundation

This document contains product specifications; properties are not guaranteed. Subject to change without notice.

KL 2 - ZB.601 -

--	--	--

 -

--	--	--

Version							
	standard	2	0	0			
	over voltage protection	2	0	1			
	version with 2 channels	2	2	0			
	HART® communication interface	2	H	0			
	HART® communication interface and over voltage protection	2	H	1			
Special version							
	standard				0	0	0
	customer				9	9	9

consult

HART® is a registered trade mark of HART Communication Foundation

This document contains product specifications; properties are not guaranteed. Detailed information about options are defined in the datasheet. Subject to change without notice.

Mounting flange with cable gland		
Technical data		
Suitable for	all probes	
Flange material	stainless steel 1.4404 (316L)	
Material of cable gland	standard: brass, nickel plated on request: stainless steel 1.4305; plastic	
Seal insert	material: TPE (ingress protection IP 68)	
Hole pattern	according to DIN 2507	
Version	Size (in mm)	Weight
DN25 / PN40	D = 115, k = 85, b = 18, n = 4, d = 14	1.4 kg
DN50 / PN40	D = 165, k = 125, b = 20, n = 4, d = 18	3.2 kg
DN80 / PN16	D = 200, k = 160, b = 20, n = 8, d = 18	4.8 kg
Ordering type		Ordering code
DN25 / PN40 with cable gland brass, nickel plated		ZMF2540
DN50 / PN40 with cable gland brass, nickel plated		ZMF5040
DN80 / PN16 with cable gland brass, nickel plated		ZMF8016

cable gland M16x1.5 with seal insert (for cable- \varnothing 4 ... 11 mm)

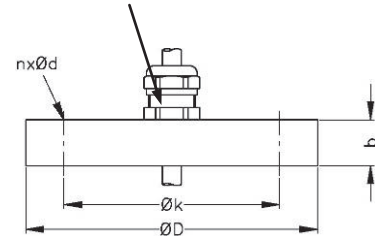

Terminal clamp		
Technical Data		
Suitable for	all probes with cable \varnothing 5.5 ... 10.5 mm	
Material	standard: steel, zinc plated optionally: stainless steel 1.4301	
Weight	approx. 160 g	
Ordering type		Ordering code
Terminal clamp, steel, zinc plated		Z100528
Terminal clamp, stainless steel 1.4301		Z100527

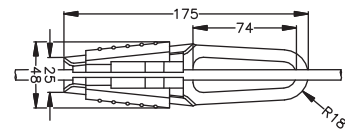

probe flange		
Technical data		
Suitable for	LMK 382, LMK 382H, LMK 458, LMK 458H	
Flange material	stainless steel 1.4404 (316L)	
Hole pattern	according to DIN 2507	
Version	Size (in mm)	Weight
DN25 / PN40	D = 115, k = 85, b = 18, n = 4, d = 14	1.2 kg
DN50 / PN40	D = 165, k = 125, b = 20, n = 4, d = 18	2.6 kg
DN80 / PN16	D = 200, k = 160, b = 20, n = 8, d = 18	4.1 kg
Ordering type		Ordering code
Transmitter flange DN25 / PN40		ZSF2540
Transmitter flange DN50 / PN40		ZSF5040
Transmitter flange DN80 / PN16		ZSF8016

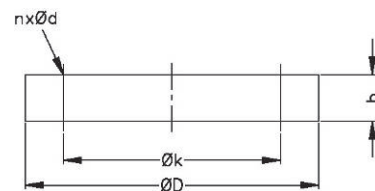

	Description	Display	Input
PA 430	Plug-on Display self powered with Contacts and Ex-approval	4-digit LED-display 4 x 7 mm, rotatable	4 ... 20 mA, 0 ... 10 V
PA 440	Field Display with Contacts and Ex-approval	4-digit LED-display 4 x 10 mm 4-digit LCD-display 4 x 18 mm	4 ... 20 mA
PA 450	Field Display for Difference Formation	4-digit LED-display 4 x 10 mm	2 inputs: 4 ... 20 mA
CIT 200	Process Display	4-digit LED-display 4 x 13 mm	0/4 ... 20 mA, 0/1 ... 5 V, 0/2 ... 10 V, PT100 / PT500 / PT1000
CIT 250	Process Display with Contacts	4-digit LED-display 4 x 13 mm	0/4 ... 20 mA, 0/1 ... 5 V, 0/2 ... 10 V, PT100 / PT500 / PT1000
CIT 300	Process Display with Contacts and Analogue Output	4-digit LED-display 4 x 20 mm	0/4 ... 20 mA, 0/1 ... 5 V, 0/2 ... 10 V, PT100 / PT500 / PT1000
CIT 350	Process Display with Bargraph, Contacts and Analogue Output	4-digit LED-display 4 x 9 mm + 20-segment-Bargraph	0/4 ... 20 mA, 0/1 ... 5 V, 0/2 ... 10 V
CIT 400	Process Display with Contacts, Analogue Output and Ex-approval	4-digit LED-display 4 x 10 mm	4 ... 20 mA
CIT 600	Multichannel Process Display (LCD)	graphic LC-display 128 x 64 pixel	2 / 4 / 8 inputs: 0/4 ... 20 mA, PT100 / PT500 / PT1000
CIT 650	Multichannel Process Display (LCD) with Datalogger	graphic LC-display 128 x 64 pixel	1 / 4 / 8 inputs: 0/4 ... 20 mA, PT100 / PT500 / PT1000
CIT 700	Multichannel Process Display (TFT) with Contacts, Analogue Outputs and Datalogger	graphic 3,5" TFT- monitor, touchscreen	max. 48 inputs: 0 ... 20 mA, 0 ... 10 V max. 12 inputs: PT 100 / PT 500 / PT 1000 (Ω) max. 24 inputs: thermocouple (mV)
CIT 750	Multichannel Process Display (TFT) with Contacts, Analogue Outputs and Datalogger	graphic 5,7" TFT- monitor, touchscreen	max. 72 inputs: 0 ... 20 mA, 0 ... 10 V max. 18 inputs: PT 100 / PT 500 / PT 1000 (Ω) max. 36 inputs: thermocouple (mV)

Output	Housing Dimensions (B x H x T) in mm	Interface	
0 / 1 / 2 PNP-outputs 4 ... 20 mA, 0 ... 10 V	plastic, rotatable 47 x 47 x 68	–	
0 / 1 / 2 PNP- outputs 4 ... 20 mA	plastic 120 x 80 x 57 aluminium 125 x 80 x 57	–	
0 / 1 / 2 PNP- outputs 4 ... 20 mA	plastic 120 x 80 x 57	–	
	front panel 72 x 36 x 77 (95)	RS 485 Modbus RTU	
0 / 1 / 2 relay- outputs	front panel 72 x 36 x 77	RS 485 Modbus RTU	
0 / 2 / 4 relay- outputs 0/4 ... 20 mA	front panel 96 x 48 x 98	RS 485 Modbus RTU	
0 / 2 / 4 relay- outputs 0/4 ... 20 mA	front panel 48 x 96 x 98	RS 485 Modbus RTU	
2 / 4 relay- outputs 0/4 ... 20 mA	front panel 72 x 72 x 110 hat rail 70 x 75 x 110	–	
2 OC- outputs	front panel 96 x 96 x 100	RS 485 Modbus RTU	
2 OC- outputs	front panel 96 x 96 x 100	RS 485 Modbus RTU USB-Host Port	
max. 16 relay- outputs, max. 24 SSR-outputs, max. 8 outputs 4 ... 20 mA	front panel 96 x 96 x 100	RS 485 Modbus RTU, RS 232, Ethernet (Modbus TCP, Java Applets) USB Host Port	
max. 36 relay- outputs, max. 72 SSR-outputs, max. 24 outputs 4 ... 20 mA	front panel 144 x 144 x 100	RS 485 Modbus RTU, RS 232, Ethernet (Modbus TCP, Java Applets) USB Host Port	

COMPETENCE

Industrial pressure measurement technology from 0.1 mbar up to 6000 bar

→ pressure transmitters, electronic pressure switches or hydrostatic level probes

→ OEM or high-end products

→ standard products or customized solutions

BD|SENSORS has the right pressure measuring device at the right price.

PRICE / PERFORMANCE

pressure measurement at the highest level

The concentration on electronic pressure transmitter has led to extraordinary efficiency and economical pricing.

BD|SENSORS is certain to be one of the most economical suppliers on the world market, given equal technical and commercial conditions.

RELIABILITY

projectable delivery times and strict observance of deadlines

Short delivery times and firm deadlines, even for special designs, make BD|SENSORS a reliable partner for our customers.

BD|SENSORS reduces the level of your stock-keeping and increases your profitability.

FLEXIBILITY

We have special solutions for your individual requirement.

We solve your problem in industrial pressure measurement quickly and economically, not only with large-scale production lines, but also for smaller requirements.

BD|SENSORS is especially flexible when technical support and quick assistance are required in service case as well as for rush orders.

INDUSTRIES



plant and machine engineering



chemical and biochemical industry



energy industry



renewable energy



semiconductor industry /
cleanroom technology



HVAC



hydraulics



refrigeration



calibration techniques



laboratory techniques



medical technology



food and beverage



vehicles and mobile hydraulics



oil and gas industry



pharmaceutical industry



marine / shipbuilding / offshore



heavy industry



environmental industry



packaging and paper industry

MEDIA



sewage



aggressive media



colours



gases



fuels and oils



pasty and viscous media



oxygen



water



*DISTRIBUTION WORLDWIDE
HEADQUARTER OF BD|SENSORS GROUP*

*BD | SENSORS GmbH
BD-Sensors-Straße 1
95199 THIERSTEIN
GERMANY*

*Tel.: +49 9235 9811-0
Fax: +49 9235 9811-11*

*www.bdsensors.de
info@bdsensors.de*

DISTRIBUTION EASTERN EUROPE

*BD | SENSORS s.r.o.
Hradištská 817
687 08 BUCHLOVICE
CZECH REPUBLIC*

*Tel.: +420 572 411-011
Fax: +420 572 411-497*

*www.bdsensors.cz
sale@bdsensors.cz*