

# K LINE • Converters / Isolators

## 6,2 mm housing

# K111

Dual output frequency trip amplifier for on/off sensors



CE

<b>Power supply</b>	19,2..30 Vdc
<b>Power consumption</b>	< 25 mA
<b>Input</b>	1 channel, IEC1131, Namur, 2/3 wires PNP/NPN, reed, photocell
<b>Input</b>	Max frequency 20 kHz, min 1 pulse every 116'
<b>Output</b>	2 channels settable as alarms or frequency, PNP, max current 200 mA
<b>Galvanic isolation</b>	1,5 kVac
<b>Status indicator</b>	3 LED, power, thresholds, error
<b>Connections</b>	Spring clamps, SMART SUPPLY power
<b>Small dimensions</b>	6,2 x 93,1 x 102,5 mm [w x h x d]
<b>Operating temperature</b>	-10..+65 °C



TR AUTOMATYKA Sp. z o.o.

ul. Lechicka 14  
02-156 Warszawa  
email: biuro@trautomatyka.pl

tel.: +48 22 886 10 16  
fax: +48 22 846 50 37

# K111

## Dual output frequency trip amplifier for on/off sensors



### ORDER CODE

<b>Model</b>	<b>K111</b>	Dual output frequency trip amplifier for on/off sensors
<b>Accessories</b>	<b>K-BUS</b> <b>K-SUPPLY</b>	Expandable power supply connector Power Supply module with surge protection
<b>Programming Kit</b>	<b>S117P</b>	Easy-K111 software + USB adapter

## TECHNICAL FEATURES

### GENERAL FEATURES

<b>Power supply</b>	19.2..30 Vdc
<b>Channels number</b>	1 input, 2 outputs
<b>Thermal drift</b>	< 100 ppm/K
<b>Status indicators</b>	Power, 2 settable (input, output, threshold, fix, inverted)
<b>Galvanic isolation</b>	1.5 kVac, 2 ways
<b>Power supply on side terminals</b>	Yes
<b>Hot swapping</b>	Yes
<b>Power consumption @ 24 V</b>	< 23 mA (2 wire sensors) < 40 mA (3 wire sensors, supplying 20mA)
<b>Power for sensors</b>	Range: 8±0.6 V, 12±1 V, 22±2 V Internal impedance: ~ 1 kΩ (Namur, photocell), ~ 40 Ω (sensor power) Current 3 wires: Max 22 mA (continue), 35 mA (d.c.)
<b>Programming</b>	DIP switches (only input type) and PC program
<b>Dimensions (wxhxd)</b>	6.2 x 93.1 x 102,5 mm
<b>Housing, weight, colour</b>	PBT, 45 g, black
<b>Operating temperature</b>	-10..+65 °C
<b>Connections</b>	Spring clamps and/or bus (EN 60175)
<b>Protection degree</b>	IP20
<b>Approvals</b>	CE, EN 61000-6-4, EN 64000-6-2, EN 61010-1

### INPUT

<b>Channels</b>	1
<b>Type</b>	Mechanical contact, per std. IEC1131.2 type 1, NAMUR (DIN19234, EN60947-5-6), 2/3 wire NPN o PNP (12 or 22 V), Reed, photo, AICHI devices.
<b>Switching threshold</b>	~ 1.6 mA (Namur, PNP), ~ 3 mA (NPN)
<b>Hysteresis</b>	~ 0.2 mA
<b>Frequency</b>	DC, 1/36 h..20 kHz (calculation on N pulses, N ≤256)
<b>Min active time</b>	10 μs
<b>Max voltage</b>	±28 V

### OUTPUT

<b>Channels</b>	2
<b>Type</b>	PNP (input repetition, threshold, window, divider, fix, inverted)
<b>Max current</b>	±200 mA (per output)
<b>Protection</b>	Self-restoring fuse
<b>Max voltage</b>	±30 V (continuous), ±50 V (peak)

## INSTALLATION, CONNECTION, DIMENSIONS

### INSERTION/ MODULES REMOVAL

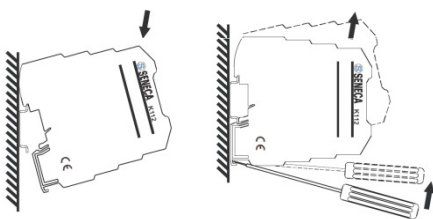

### K-BUS CONNECTOR

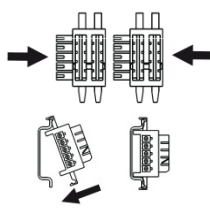

### SPRING-CLAMPS

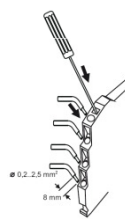

### DIMENSIONS

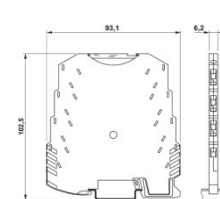

### POWER SUPPLY

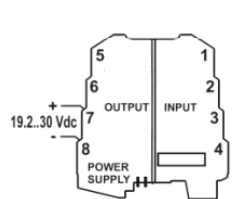

### INPUTS

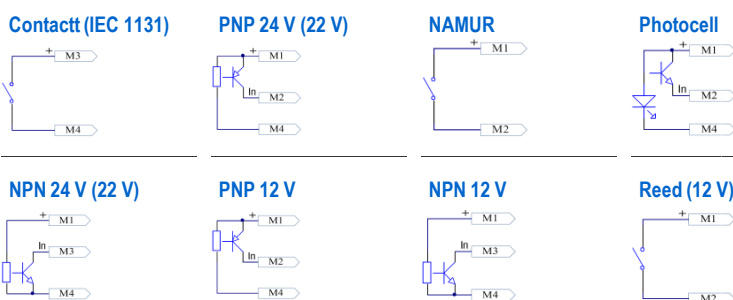

### OUTPUTS (PNP)

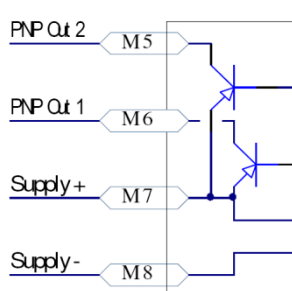

### PROGRAMMING PORT

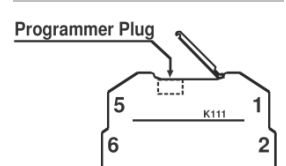

TR AUTOMATYKA Sp. z o.o.

ul. Lechicka 14  
02-156 Warszawa

email: [biuro@trautomatyka.pl](mailto:biuro@trautomatyka.pl)

tel.: +48 22 886 10 16  
fax: +48 22 846 50 37