

Characteristics:

General Description:

The single channel Temperature Signal Converter, Trip amplifiers D5273S accepts a low level dc signal from millivolt, thermocouple or 2-3-4 wire RTD or transmitting potentiometer sensors, located in Hazardous Area, and converts, with isolation, the signal to drive a Safe Area load, suitable for applications requiring SIL 2 level (according to IEC 61511) in safety related systems for high risk industries.

Output signal can be direct or reverse.

Output function can be configured as: Adder, subtractor, low/high selector.

Modbus RTU RS-485 output is available on Bus connector.

Cold junction compensation can be programmed as automatic, using an internal temperature sensor or fixed to a user-customizable temperature value.

D5273S offers two independent trip amplifiers via two SPDT output relays.

Mounting on standard DIN-Rail, with or without Power Bus, in Safe Area / Non Hazardous Location or in Zone 2 / Class I, Division 2 or Class I, Zone 2.

Fault Detection:

D5273S is able to detect multiple fault sources:

- Sensor Burnout (i.e. when input is disconnected);
- Sensor out of configured range;
- Analog output saturation (beyond user-configured output limits);
- Internal module fault;
- Module out of allowed temperature range (-40 to +70 °C).

The module can be programmed to reflect such fault conditions on Analog Output (Upscale, Downscale, Custom Value) and/or on each Alarm Output.

All data is available also via Modbus Output.

Front Panel and Features:

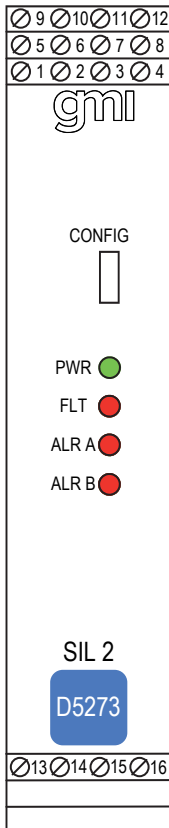

- D5273S SIL 2 according to IEC 61511 for Tproof = 3/10 years (≤10% / >10 % of total SIF), PFDavg (1 year) 3.15 E-04, SFF 77.08% with analog current output.
- D5273S SIL 2 according to IEC 61511 for Tproof = 2/10 years (≤10% / >10 % of total SIF), PFDavg (1 year) 3.76 E-04, SFF 74.95% with single alarm trip amplifier and relay output.
- Input from Zone 0 (Zone 20), installation in Zone 2.
- mV, thermocouple, 2 or 3 or 4 wire RTD or transmitting potentiometer Input Signal.
- 2-wire RTD line resistance compensation.
- Internal Reference Junction Compensation automatic or fixed (programmable value).
- Fastest integration time: 50 ms
- 4-20 mA Output Signal temperature linear or reverse.
- Two independent Trip Amplifiers each with SPDT relay contacts 4A 250 Vac 1000VA
- Multiple Fault detection.
- High Accuracy, μ P controlled A/D converter.
- Three port isolation, Input/Output/Supply.
- EMC Compatibility to EN61000-6-2, EN61000-6-4, EN61326-1, EN61326-3-1 for safety system.
- Fully programmable operating parameters.
- ATEX, IECEx, FM, FMC, INMETRO, EAC-EX, UKR TR n. 898, TÜV Certifications.
- Type Approval Certificate DNV and KR for maritime applications.
- High Density, one Analog Output + two Alarms.
- Simplified installation using standard DIN-Rail and plug-in terminal blocks, with or without Power Bus.
- 250 Vrms (Um) max. voltage allowed to the instruments associated with the barrier.

Technical Data:

Supply: 24 Vdc nom (18 to 30 Vdc) reverse polarity protected, ripple within voltage limits ≤ 5 Vpp, 2 A time lag fuse internally protected.

Current consumption @ 24 V: 50 mA with 20 mA output and relays energized typical.

Power dissipation: 1.3 W with 24 V supply, 20 mA output and relays energized typical.

Isolation (Test Voltage): I.S.In/Outs 1.5kV; I.S.In/Supply 2.5kV; Analog Out/Supply 500V; Analog Out/Alarm Outs 1.5kV; Alarm Outs/Supply 1.5kV; Alarm Out/Alarm Out 1.5kV.

Input: millivolt or thermocouple type A1, A2, A3, B, E, J, K, L, LR, N, R, S, T, U, or 2-3-4 wire RTD Pt50, Pt100, Pt200, Pt300, Pt400, Pt500, Pt1000 (IEC), Pt100 (ANSI 0.3916), Ni100, Ni120 (DIN43760), Pt46, Pt50, Pt100, Pt200, Pt300, Pt400, Pt500, Cu50, Cu53, Cu100 (GOST6651 russian standard) and Cu9.035 (or Cu10), or 3 wire transmitting potentiometer (100 Ω to 10 k Ω). Choice between °C/°F.

Possibility of configuring user customized sensor (TC or RTD).

Integration time: from 50 ms to 500 ms depending on sensor and fast/slow integration.

Resolution: 1 μ V on mV/TC, 1 m Ω on RTD/resistance, 0.0001 % on potentiometer.

Visualization: 0.1 °C on temp., 10 μ V on mV, 100 m Ω on resistance, 0.1 % on pot.

Input range: within sensor limits (-50 to +80 mV for TC/mV, 0-4 k Ω for resistance).

Measuring RTD current: ≤ 0.15 mA. **2 wire RTD line resistance compensation:** ≤ 100 Ω (programmable).

Thermocouple Reference Junction Compensation: programmable as automatic with internal compensator or fixed (-60 to +100 °C). **Thermocouple burnout current:** ≤ 50 μ A.

Fault: enabled/disabled. Analog output can be programmed to reflect fault conditions via downscale, highsacle or customized value forcing. Fault conditions are also signaled via BUS and by red LED on front panel for each channel. Fault conditions are: Sensor burnout, Sensor out of range, Output saturation, Internal fault, Module out of temperature range.

Output: Fully customizable 0/4 to 20 mA, on max. 300 Ω load source mode, current limited at 24 mA. In sink mode, external voltage generator range is V min. 3.5V at 0 Ω load and V max. 30V. If generator voltage Vg > 10 V, a series resistance $\geq (Vg - 10) / 0.024$ Ω is needed. The maximum value of series resistance is (Vg - 3.5)/0.024 Ω .

Resolution: 1 μ A current output.

Transfer characteristic: linear, direct or reverse on all input sensors.

Response time: ≤ 20 ms (10 to 90 % step). **Output ripple:** ≤ 20 mVrms on 250 Ω load.

Modbus Output: Modbus RTU protocol up to 115.200 baud on Bus connector.

Alarm: Trip point range: within rated limits of input sensor (see input step resolution).

ON-OFF delay time: 0 to 1000 s, 100 ms step. **Hysteresis:** 0-500 °C, 0-50 mV, 0-50 %.

Output: Two voltage free SPDT relay contacts. **Contact material:** Ag Alloy (Cd free).

Contact rating: 4 A 250 Vac 1000 VA, 4 A 250 Vdc 120 W (resistive load).

Mechanical / Electrical life: $5 \cdot 10^6 / 3 \cdot 10^4$ operation, typical.

Operate / Release time: 8 / 4 ms typical. **Bounce time NO / NC contact:** 3 / 8 ms, typical.

Frequency response: 10 Hz maximum.

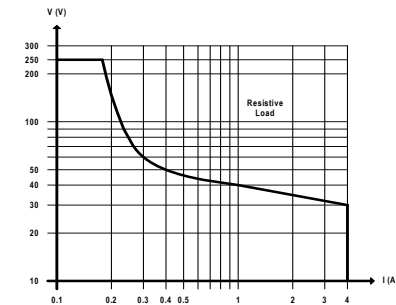

DC Load breaking capacity: Performance Ref. Conditions 24 V supply, 250 Ω load, 23 ± 1 °C ambient temperature, slow integration speed, 4-wires configuration for RTD.

Input: Calibration and linearity accuracy: see section "Input Specifications".

Temperature influence: $\leq \pm 2$ μ V on mV or thermocouple, ± 20 m Ω on RTD (≤ 300 Ω @ 0°C) or ± 200 m Ω on RTD (> 300 Ω @ 0°C), ± 0.02 % on potentiometer for a 1 °C change.

Ref. Junction Compensation influence: $\leq \pm 1$ °C (thermocouple sensor).

Analog Output: Calibration accuracy: $\leq \pm 0.05$ % of full scale.

Linearity error: $\leq \pm 0.05$ % of full scale.

Supply voltage influence: $\leq \pm 0.02$ % of full scale for a min to max supply change.

Load influence: $\leq \pm 0.02$ % of full scale for a 0 to 100 % load resistance change.

Temperature influence: $\leq \pm 0.01$ % on zero and span for a 1 °C change.

Compatibility: CE mark compliant, conforms to Directive: 2014/34/EU ATEX, 2014/30/EU EMC, 2014/35/EU LVD, 2011/65/EU RoHS.

Environmental conditions: **Operating:** temperature limits -40 to +70 °C, relative humidity 95 %, up to 55 °C. **Storage:** temperature limits -45 to +80 °C.

Safety Description:



ATEX: II 3(1)G Ex nA nC [ia Ga] IIC T4 Gc, II (1)D [Ex ia Da] IIC, I (M1) [Ex ia Ma] I

IECEx / INMETRO: Ex nA nC [ia Ga] IIC T4 Gc, [Ex ia Da] IIC, [Ex ia Ma] I, associated apparatus and non-sparking electrical equipment

Uo/Voc=7.2V, Iolsc=23mA, Po/Po=40mW, Ui/Vmax=12.8V, Ii/Imax=28.7mA, Ci=0nF, Li=0nH at terminals 13-14-15-16. Um=250Vrms, -40 °C \leq Ta \leq 70 °C.

Approvals:

BVS 12 ATEX E 053 X conforms to EN60079-0, EN60079-11, EN60079-15

IECEx BVS 12.0050X conforms to IEC60079-0, IEC60079-11, IEC60079-15

INMETRO DNV 13.0110 X conforms to ABNT NBR IEC60079-0, ABNT NBR IEC60079-11, ABNT NBR IEC60079-15, ABNT NBR IEC60079-26

FM 3046304 and FMC 3046304C conforms to Class 3600, 3610, 3611, 3810

ANSI/ISA-60079-0, ANSI/ISA-60079-11, ANSI/ISA-60079-15, C22.2 No.142, C22.2 No.157, C22.2 No.213, C22.2 No. 60079-0, C22.2 No. 60079-11, C22.2 No. 60079-15

C-IT.MH62.B.04182 conforms to GOST R IEC 60079-0, GOST R IEC 60079-11, GOST R IEC 60079-15.

CL1 16.0036 X conforms to DCTY 7113, GOCT 22782.5-78, DCTY IEC 60079-15.

DNV Type Approval Certificate No.A-13625 and KR No.MIL20769-EL002 Certificates for maritime applications.

TUV Certificate No. C-IS-236198-02 SIL 2 according to IEC 61511.

Mounting: 135 DIN-Rail according to EN50022, with or without Power Bus.

Weight: 120 g.

Connection: by polarized plug-in disconnect screw terminal blocks to accommodate terminations up to 2.5 mm².

Location: installation in Safe Area/Non Hazardous Locations or Zone 2, Group IIC T4 or Class I, Division 2, Group A,B,C,D, T4 or Class I, Zone 2, Group IIC, T4.

Protection class: IP 20.

Dimensions: Width 22.5 mm, Depth 123 mm, Height 120 mm.

Ordering Information:

Model:	D5273	Power Bus and DIN-Rail accessories:
1 channel	S	Connector JDFT050
		Cover and fix MCHP196
		Terminal block male MOR017
		Terminal block female MOR022

Operating parameters are programmable from PC by the GM Pocket Portable Adapter PPC5092 via USB serial line and SWC5090 Configurator software.

Parameters Table:

Safety Description	Maximum External Parameters			
	Group Cenelec	Co/Ca (µF)	Lo/La (mH)	Lo/Ro (µH/Ω)
D5273S: Terminals 13-14-15-16	IIC	13.5	67	875
Uo/Voc = 7.2 V	IIB	240	268	3500
Io/Isc = 23 mA	IIA	1000	537	7000
Po/Po = 40 mW	I	1000	882	11480
Ui/Vmax = 12.8 V	IIIC	240	268	3500
Ii/Imax = 28.7 mA				
Ci = 0 nF, Li = 0 nH				

NOTE for USA and Canada:

IIC equal to Gas Groups A, B, C, D, E, F and G

IIB equal to Gas Groups C, D, E, F and G

IIA equal to Gas Groups D, E, F and G

Image:



Function Diagram:

HAZARDOUS AREA ZONE 0 (ZONE 20) GROUP IIC,
HAZARDOUS LOCATIONS CLASS I, DIVISION 1, GROUPS A, B, C, D,
CLASS II, DIVISION 1, GROUPS E, F, G, CLASS III, DIVISION 1,
CLASS I, ZONE 0, GROUP IIC

SAFE AREA, ZONE 2 GROUP IIC T4,
NON HAZARDOUS LOCATIONS, CLASS I, DIVISION 2,
GROUPS A, B, C, D T-Code T4, CLASS I, ZONE 2, GROUP IIC T4

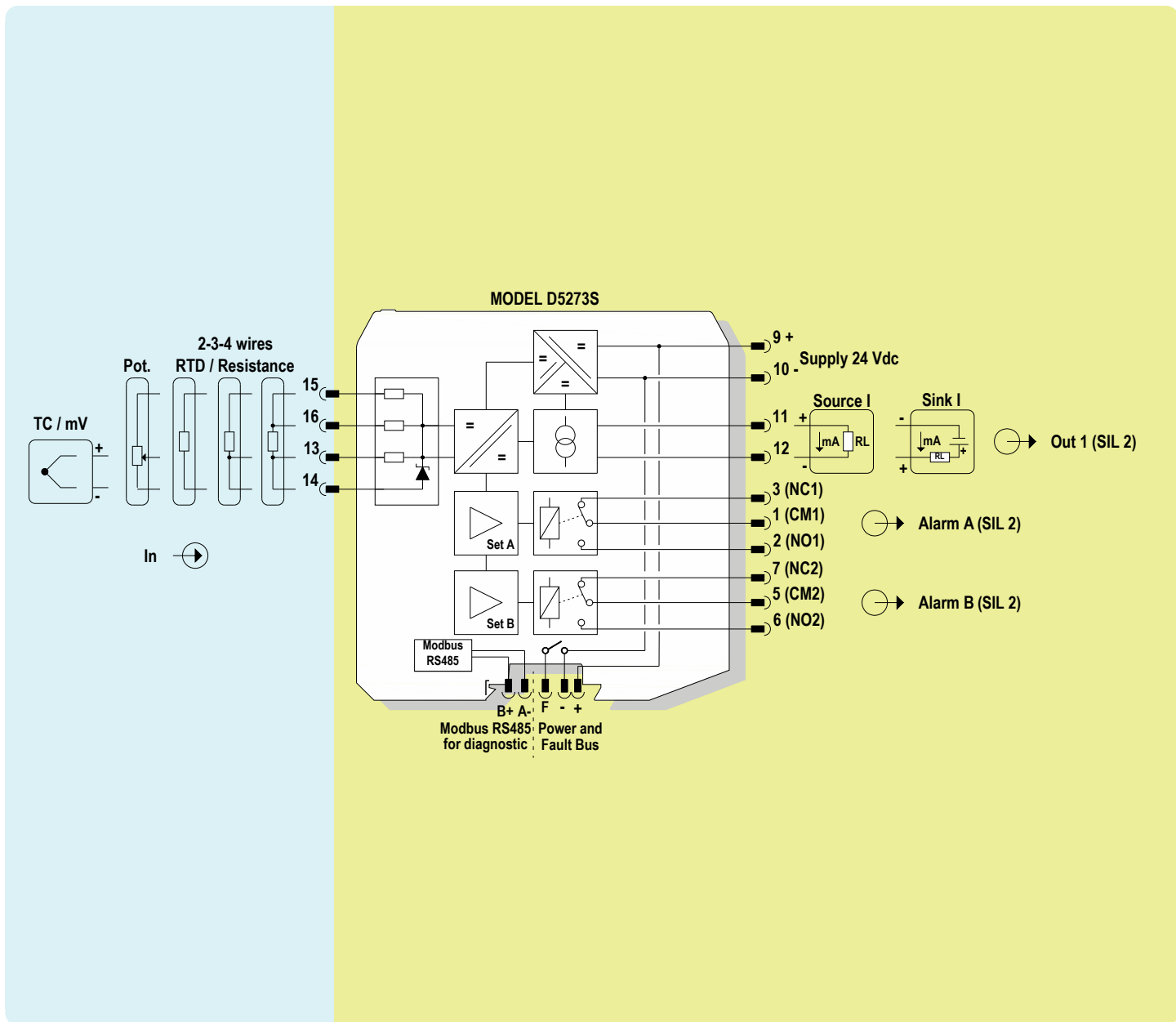

Input specifications:

Input	Type	Alpha	Ohms	Standards	Min Span	Accuracy	Accuracy Range	Maximum Range
RTD	Platinum	0.003850	50	IEC 60751	30 °C (54 °F)	±0.4 °C ±0.7 °F	-200 to 850 °C (-328 to 1562 °F)	-200 to 850 °C (-328 to 1562 °F)
			100	IEC 60751	20 °C (36 °F)	±0.2 °C ±0.4 °F	-200 to 850 °C (-328 to 1562 °F)	-200 to 850 °C (-328 to 1562 °F)
			200	IEC 60751		±0.2 °C ±0.4 °F	-200 to 850 °C (-328 to 1562 °F)	-200 to 850 °C (-328 to 1562 °F)
			300	IEC 60751		±0.2 °C ±0.4 °F	-200 to 850 °C (-328 to 1562 °F)	-200 to 850 °C (-328 to 1562 °F)
			400	IEC 60751		±0.2 °C ±0.4 °F	-200 to 850 °C (-328 to 1562 °F)	-200 to 850 °C (-328 to 1562 °F)
			500	IEC 60751		±0.2 °C ±0.4 °F	-200 to 850 °C (-328 to 1562 °F)	-200 to 850 °C (-328 to 1562 °F)
			1000	IEC 60751		±0.2 °C ±0.4 °F	-200 to 850 °C (-328 to 1562 °F)	-200 to 850 °C (-328 to 1562 °F)
		0.003916	100	ANSI		20 °C (36 °F)	±0.2 °C ±0.4 °F	-200 to 625 °C (-328 to 1157 °F)
		0.003910	46	GOST 6651	30 °C (54 °F)	±0.4 °C ±0.7 °F	-200 to 650 °C (-328 to 1202 °F)	-200 to 650 °C (-328 to 1202 °F)
			50	GOST 6651		±0.4 °C ±0.7 °F	-200 to 650 °C (-328 to 1202 °F)	-200 to 650 °C (-328 to 1202 °F)
			100	GOST 6651	20 °C (36 °F)	±0.2 °C ±0.4 °F	-200 to 650 °C (-328 to 1202 °F)	-200 to 650 °C (-328 to 1202 °F)
			200	GOST 6651		±0.2 °C ±0.4 °F	-200 to 650 °C (-328 to 1202 °F)	-200 to 650 °C (-328 to 1202 °F)
			300	GOST 6651		±0.2 °C ±0.4 °F	-200 to 650 °C (-328 to 1202 °F)	-200 to 650 °C (-328 to 1202 °F)
			400	GOST 6651		±0.2 °C ±0.4 °F	-200 to 650 °C (-328 to 1202 °F)	-200 to 650 °C (-328 to 1202 °F)
	500	GOST 6651	±0.2 °C ±0.4 °F	-200 to 650 °C (-328 to 1202 °F)	-200 to 650 °C (-328 to 1202 °F)			
	Nickel	0.00618	100	DIN 43760	20 °C (36 °F)	±0.2 °C ±0.4 °F	-60 to 180 °C (-76 to 356 °F)	-60 to 180 °C (-76 to 356 °F)
		0.00672	120	DIN 43760		±0.2 °C ±0.4 °F	-80 to 320 °C (-112 to 608 °F)	-80 to 320 °C (-112 to 608 °F)
	Copper	0.00428	50	GOST 6651	30 °C (54 °F)	±0.4 °C ±0.7 °F	-50 to 200 °C (-58 to 392 °F)	-50 to 200 °C (-58 to 392 °F)
			53	GOST 6651	30 °C (54 °F)	±0.4 °C ±0.7 °F	-50 to 200 °C (-58 to 392 °F)	-50 to 200 °C (-58 to 392 °F)
			100	GOST 6651	20 °C (36 °F)	±0.2 °C ±0.4 °F	-50 to 200 °C (-58 to 392 °F)	-50 to 200 °C (-58 to 392 °F)
		0.00427	9.035	---	40 °C (72 °F)	±1.0 °C ±1.8 °F	-50 to 260 °C (-58 to 500 °F)	-50 to 260 °C (-58 to 500 °F)
Ohm	Resistance	0 to 4000	---	10 ohm	±0.4 ohm	0 to 4000	0 to 4000	
	Potentiometer	100 to 10000	---	10%	±0.1%	0 to 100%	0 to 100%	
TC	A1	---	GOST 8.585-2001	100 °C (180 °F)	±0.75 °C ±1.35 °F	25 to 2500 °C (77 to 4532 °F)	-10 to 2500 °C (14 to 4532 °F)	
	A2	---	GOST 8.585-2001	100 °C (180 °F)	±0.75 °C ±1.35 °F	25 to 1800 °C (77 to 3272 °F)	-10 to 1800 °C (14 to 3272 °F)	
	A3	---	GOST 8.585-2001	100 °C (180 °F)	±0.75 °C ±1.35 °F	25 to 1800 °C (77 to 3272 °F)	-10 to 1800 °C (14 to 3272 °F)	
	B	---	IEC 60584 GOST 8.585-2001	75 °C (135 °F)	±0.75 °C ±1.35 °F	180 to 1800 °C (356 to 3272 °F)	-10 to 1800 °C (14 to 3272 °F)	
	E	---	IEC 60584 GOST 8.585-2001	40 °C (72 °F)	±0.3 °C ±0.6 °F	-100 to 1000 °C (-148 to 1832 °F)	-250 to 1000 °C (-418 to 1832 °F)	
	J	---	IEC 60584 GOST 8.585-2001	40 °C (72 °F)	±0.3 °C ±0.6 °F	-125 to 750 °C (-193 to 1382 °F)	-200 to 1200 °C (-328 to 2192 °F)	
	K	---	IEC 60584 GOST 8.585-2001	40 °C (72 °F)	±0.3 °C ±0.6 °F	-125 to 1350 °C (-193 to 2462 °F)	-250 to 1350 °C (-418 to 2462 °F)	
	L	---	DIN 43710	40 °C (72 °F)	±0.3 °C ±0.6 °F	-100 to 800 °C (-148 to 1472 °F)	-200 to 800 °C (-328 to 1472 °F)	
	LR	---	GOST 8.585-2001	40 °C (72 °F)	±0.3 °C ±0.6 °F	-75 to 800 °C (-103 to 1472 °F)	-200 to 800 °C (-328 to 1472 °F)	
	N	---	IEC 60584 GOST 8.585-2001	40 °C (72 °F)	±0.3 °C ±0.6 °F	-100 to 1300 °C (-148 to 2372 °F)	-250 to 1300 °C (-418 to 2372 °F)	
	R	---	IEC 60584 GOST 8.585-2001	50 °C (90 °F)	±0.5 °C ±0.9 °F	75 to 1750 °C (167 to 3182 °F)	-50 to 1750 °C (-58 to 3182 °F)	
	S	---	IEC 60584 GOST 8.585-2001	50 °C (90 °F)	±0.5 °C ±0.9 °F	75 to 1750 °C (167 to 3182 °F)	-50 to 1750 °C (-58 to 3182 °F)	
	T	---	IEC 60584 GOST 8.585-2001	40 °C (72 °F)	±0.3 °C ±0.6 °F	-100 to 400 °C (-148 to 752 °F)	-250 to 400 °C (-418 to 752 °F)	
	U	---	DIN 43710	40 °C (72 °F)	±0.3 °C ±0.6 °F	-100 to 400 °C (-148 to 752 °F)	-200 to 600 °C (-328 to 1112 °F)	
	mV	DC	---	---	10 mV	±10 µV	-50 to 80 mV	-50 to 80 mV

Notes:

RTD/resistance accuracy shown in 4-wires configuration, in slow acquisition mode

TC/mV Accuracy shown in slow acquisition mode

Configuration parameters:

INPUT:

Sensor Connection:

- TC
- RTD
- Potentiometer
- Voltage
- Resistance

Sensor Type: input sensor type (see list in section "Input specifications") possibility of configuring a completely customized TC/RTD input curve.

Wires: 2, 3, 4 wires selection for RTD/Resistance inputs.

Lowscale: input value of measuring range corresponding to defined low output value.

Upscale: input value of measuring range corresponding to defined high output value.

Cold Junction Source: reference junction compensation type (thermocouple only)

- Automatic via internal compensator (1 for each channel)
- Fixed programmable temperature compensation at fixed temperature

Cold Junction Reference: fixed temperature compensation value (Cold Junction type Fixed only), range from -60 to +100 °C.

Integration speed:

- Slow 250 ms (mV/TC, 2 wire RTD); 375 ms (Pot.), 500 ms (3,4 wire RTD)
- Fast 50 ms (mV/TC, 2 wire RTD); 75 ms (Pot.), 100 ms (3,4 wire RTD)

Mains Frequency:

- 50 Hz
- 60 Hz only available with fast integration speed

Offset: value to be added/subtracted to input (µV or mΩ depending on input sensor);

Multiplier: input multiplication value;

Tag: 16 alphanumeric characters

OUTPUT:

Function:

- Input 1 analog output represents input of first channel,

Type:

- 4-20 mA Sink (for SIL applications)
- 0-20 mA Sink
- Custom Sink fully customizable range from 0 to 24 mA, Sink mode
- 4-20 mA Source (for SIL applications)
- 0-20 mA Source
- Custom Source fully customizable range from 0 to 24 mA, Source mode

Downscale: output downscale in normal condition (range 0 to 24 mA)

Upscale: output upscale in normal condition (range 0 to 24 mA)

Under Range: analog output downscale in Under Range condition (range 0 to 24 mA)

Over Range: analog output upscale in Over Range condition (range 0 to 24 mA)

Fault Output Value: analog output value in case of fault condition (range 0 to 24 mA)

Fault in case of: analog output is forced to "Fault Output Value" in case of:

- Burnout input sensor interruption,
- Internal fault module internal fault,
- Sensor out of range input sensor out of configured input range,
- Output Saturation output is below Under Range or above Over Range,
- Module Temp. Out of range internal module temperature under or over specified module operating temperature limits.

ALARM:

Type:

- None alarm is disabled,
- Low alarm is triggered when source descends below "Low Set",
- LowLock alarm is inhibited until source ascends over "Low Set", and then, it behaves as a standard "Low" configuration,
- High alarm is triggered when source ascends over "High Set",
- HighLock alarm is inhibited until source descends below "High Set", and then, it behaves as a standard "High" configuration,
- Window alarm is triggered below "Low Set" and above "High Set",
- Fault Repeater alarm output reflects selected (one or more) Fault status.

Source: reference value for alarm triggering

- Input 1 input of first channel

Condition:

- NE alarm output is normally energized when deactivated, for SIL applications

- ND alarm output is normally de-energized when deactivated.

Low Set: source value at which the alarm is triggered (in Low, LowLock, Window)

Low Hysteresys: triggered Low alarm deactivates when source value reaches Low Set + Low Hysteresys (0-500 °C, 0-50 mV, 0-50 %)

High Set: source value at which the alarm is triggered (in High, HighLock, Window)

High Hysteresys: triggered High alarm deactivates when source value reaches High Set - High Hysteresys (0-500 °C, 0-50 mV, 0-50 %)

On Delay: time for which the source variable has to be in alarm condition before the alarm output is triggered; configurable from 0 to 1000 seconds in steps of 100 ms

Off Delay: time for which the source variable has to be in normal condition before the alarm output is deactivated; configurable from 0 to 1000 seconds in steps of 100 ms

In case of fault:

- Ignore alarm is not affected
- Lock status alarm remains in the same status as it was before Fault occurred
- Go On alarm is triggered,
- Go Off alarm is deactivated

Faults: if "Type" is set to "Fault repeater" select which faults will be repeated by alarm output; if "In case of fault" is different from "Ignore", select which faults should influence alarm output behaviour.

Note: Each Alarm has completely independent configurations
See ISM0154 Manual for details on SWC5090 software.

Screenshots:

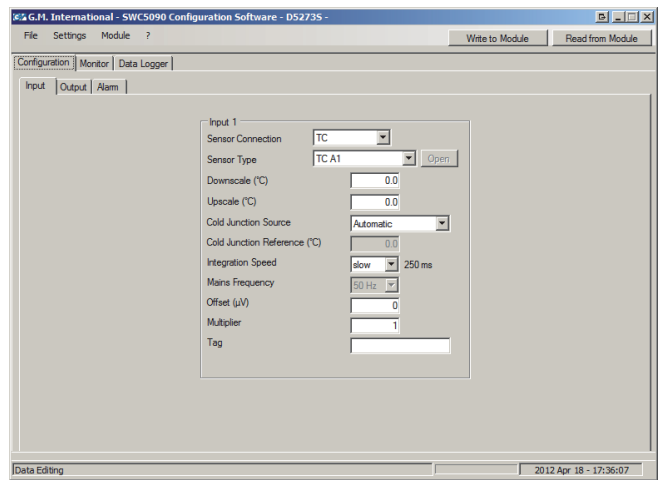

Input configuration

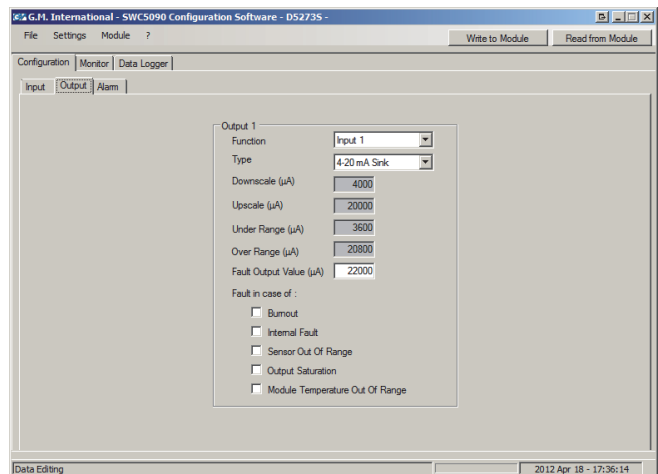

Output configuration

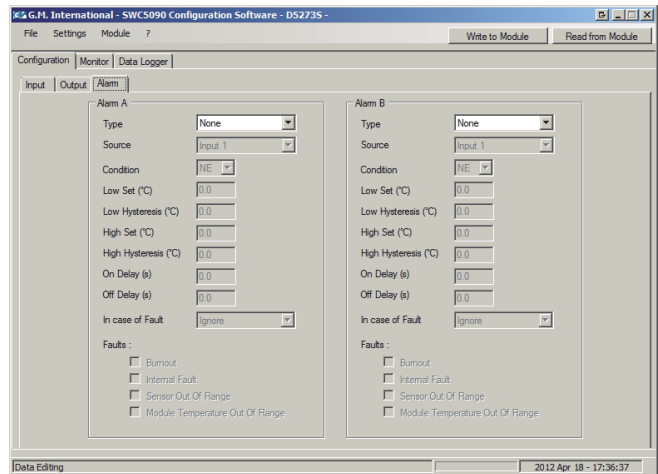

Alarm configuration

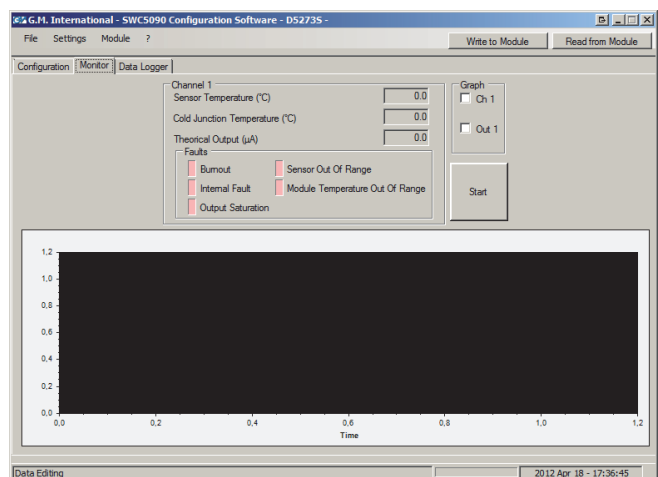

Monitor