

**Instruction sheet for BA369  
Intrinsically safe battery powered clock**



The BA369C clock is CE marked to show compliance with the European Explosive Atmospheres Directive 94/9/EC and the European EMC Directive 2004/108/EC

**1. INTRODUCTION**

The BA369 is an intrinsically safe, battery powered digital clock which can display local time in a hazardous area. It is a self contained panel mounting instrument with a selectable twelve or twenty four hour display. All controls are located on the front panel and may be protected by a security code to prevent unauthorised adjustment.

If required the display may be synchronised to a master clock via a simple external contact closure.

The BA369 clock is ATEX certified Group II Category 1G, EEx ia IIC T5 allowing installation in all Zones and use with most hazardous gases.

**2. INTRINSIC SAFETY CERTIFICATION**

**2.1 ATEX certificate**

The BA369 clock has been issued with EC-Type Examination Certificate number ITS02ATEX2017 by Notified Body Intertek Testing Services (ITS) confirming compliance with the European ATEX Directive 94/9/EC for Group II, Category 1, gas atmospheres, EEx ia IIC T5. The instrument bears the Community Mark and, subject to local codes of practice, may be installed in any of the European Economic Area (EEA) member countries. i.e. Austria, Belgium, Denmark, Finland, France, Germany, Greece, Ireland, Italy, Luxembourg, Norway, The Netherlands, Portugal, Spain, Sweden and the United Kingdom. ATEX certificates are also accepted in Iceland, Liechtenstein, Switzerland and the Czech Republic.

This instruction sheet describes installations which conform with BS EN60079:Part 14 Electrical Installation in Hazardous Areas. When designing systems for installation outside the UK, the local Code of Practice should be consulted.

**2.2 Zones, Gas Groups and T rating**

The BA369 clock has been certified EEx ia IIC T5 and may be installed in:

- Zone 0 explosive gas air mixture continuously present.
- Zone 1 explosive gas air mixture likely to occur in normal operation.
- Zone 2 explosive gas air mixture not likely to occur, and if it does, it will only exist for a short time.

Be used with gases in groups:

- Group A propane
- Group B ethylene
- Group C hydrogen

Having a temperature classification of:

- T1 450°C
- T2 300°C
- T3 200°C
- T4 135°C
- T5 100°C

Although certified intrinsically safe at ambient temperatures between -40 and +50°C the guaranteed operating temperature range of the clock is -20 to +50°C.

**WARNING installation in Zone 0**

When installed in a Zone 0 potentially explosive atmosphere requiring apparatus of Category 1G, the clock shall be installed such that even in the event of rare incidents, an ignition source due to impact or friction between the aluminium enclosure at the rear of the instrument mounting panel and iron/steel is excluded.

**2.3 Internal battery**

The BA369 is powered by a replaceable intrinsically safe battery which will operate the clock for at least two years. A replacement intrinsically safe battery may be installed while the clock is mounted within the hazardous area. See section 6.1 for detailed instructions.

**2.4 Synchronising terminals**

Connecting terminals 1 and 2 together will stop the clock. When the terminals are disconnected the clock will re-start from a new time selected in the programme menu. This may be the nearest minute or the nearest hour to the original display, or a preset time may be entered during programming. This function allows a BA369 clock to be synchronised with a master clock.

In addition to the EC-Type Examination Certificate, ITS have issued two System Certificates illustrating how the synchronising terminals of up to ten BA369 clocks may be interconnected within the hazardous area. These certificates are only for guidance and are not part of the BA369 ATEX certification.

Fig 1 shows how up to ten BA369 clocks may be synchronised by a mechanically operated hazardous area switch. Any switch may be used providing it has IP20 protection and will withstand a 500V rms insulation test for one minute.

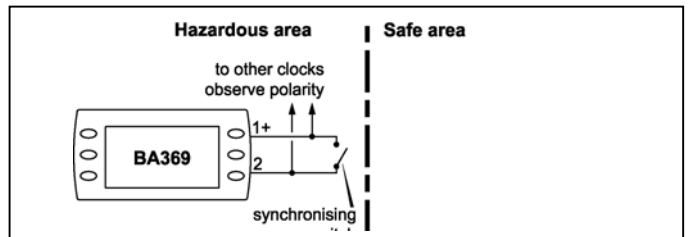

Fig 1 Synchronising display from hazardous area

If the synchronising switch is located in the safe area, the contact closure must be transferred to the hazardous area via a certified intrinsically safe Zener barrier or galvanic isolator. Any single channel Zener barrier certified EEx ia by a European Notified Body may be used providing its safety output parameters do not exceed:

- Uo = 10V dc
- Io = 200mA dc
- Po = 0.7W

To synchronise up to ten clocks the 'on' resistance of the switch plus the end-to-end resistance of the Zener barrier must be less than 500Ω and the 'off' resistance must be greater than 30kΩ. See Fig. 2 and System Certificate Ex02E2018.

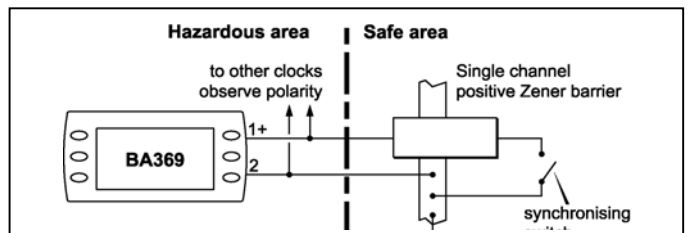

Fig 2 Synchronising display from safe area via Zener barrier

As shown in Fig 3 a galvanic isolator or intrinsically safe relay may also be used to transfer the synchronising switch contact closure into the hazardous area. System Certificate Ex02E2019 lists some suitable devices, but others may be used.

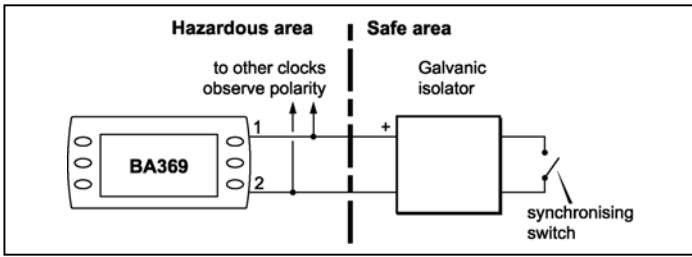

Fig 3 Synchronising display from safe area via galvanic isolator

### 2.5 Certification label information

The certification information label is fitted on the top of the clock. It shows the model number, ATEX certification information, BEKA associates address, the year of manufacture and the clock serial number.



Fig 4 Label

## 3. INSTALLATION

### 3.1 Location

The BA369 clock is housed in a robust aluminium enclosure with a Noryl bezel and elastomeric keypads. The front of the instrument provides IP65 protection and a gasket seals the joint between the instrument enclosure and the panel. The clock may be installed in any panel providing the environmental limits shown in the specification are not exceeded. Please consult BEKA associates if high vibration is anticipated.

Fig 5 shows the overall dimensions of the BA369 and the required panel cut-out. To achieve an IP65 seal between the clock enclosure and the panel the smaller cut-out must be used and the clock secured with four panel mounting clips.

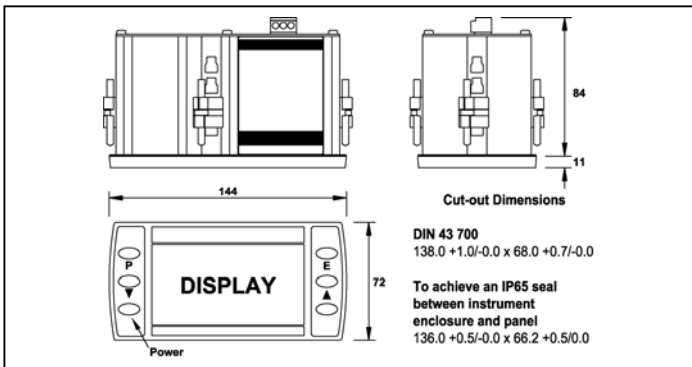

Fig 5 BA369 dimensions

### 3.2 Installation Procedure

- Insert the BA369 into the instrument panel cut-out from the front of the panel.
- Fix panel mounting clips to opposite sides of the instrument and tighten until the instrument is secure as shown in Fig 6. Four clips are required to achieve an IP65 seal between the instrument enclosure and the panel.
- For personnel safety connect the case terminal at the rear of the instrument to a local earth.

- If the synchronising facility is being used connect the panel wiring to the rear terminal block as shown in Figs 1, 2 or 3. To simplify installation, the terminal block is removable so that panel wiring can be completed before the instrument is installed.
- To extend battery life, when delivered the clock will be switched off. To activate, press the lower left hand button for about three seconds which will result in a flashing display indicating that time and date should be entered. If a time is not entered within five minutes, the clock will automatically switch off.

### 3.3 EMC

The BA369 complies with the requirements of the European EMC Directive 2004/108/EC. For specified immunity the synchronising wiring should be in screened twisted pairs.

To prevent circulating currents, cable screens should only be earthed at one point in the safe area.

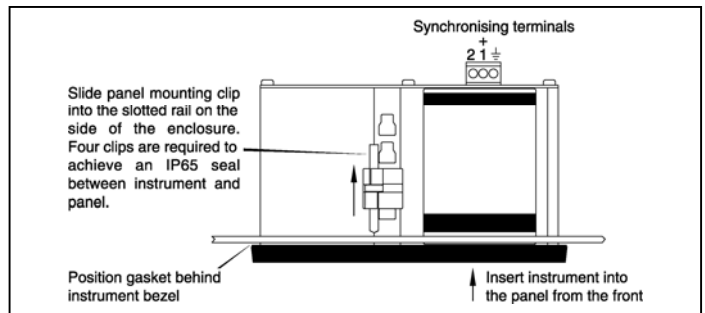

Fig 6 Installation and terminal connections

## 4. ADJUSTMENT & PROGRAMMING

The BA369 clock is adjusted and programmed via the front panel push-buttons. In normal operation these buttons have the following functions:

### Description of push-button functions

- |                               |   |
|-------------------------------|---|
| <b>Lower left hand button</b> | Operating this button for about 3 seconds turns the BA369 clock on.   |
| <b>P + E</b>                  | Operating these buttons simultaneously will enter the programme menu shown in Fig 7 which allows the display format, time and date to be entered. |
| <b>Up</b>                     | While this button is operated the display will show seconds.  |
| <b>Down</b>                   | While this button is operated the display will show the date.   |

### 4.1 Programme functions

Throughout these instructions push-buttons are shown in italics e.g. *P* or *Up* push-button and legends displayed by the clock are shown within inverted commas e.g. 'dAtE' and 'rSEt'.

Access to the programme menu is obtained by operating the *P* and *E* push-buttons simultaneously. If the clock is not protected by a security code the first parameter 'SEt' will be displayed. If a security code other than the default code 0000 has already been entered, the clock will display 'COdE'. Press *P* to clear this prompt and enter the security code for the clock using the *Up* or *Down* push-buttons to adjust each digit, and the *P* push-button to move control to the next digit. If the correct code has been entered pressing *E* will then cause the first parameter 'SEt' to be displayed. If an incorrect code is entered, or a push-button is not operated within five minutes, the clock will automatically return to the display mode.

Fig 7 shows the programme menu illustrating how to navigate between functions. A detailed description of each function is contained in the following sections.

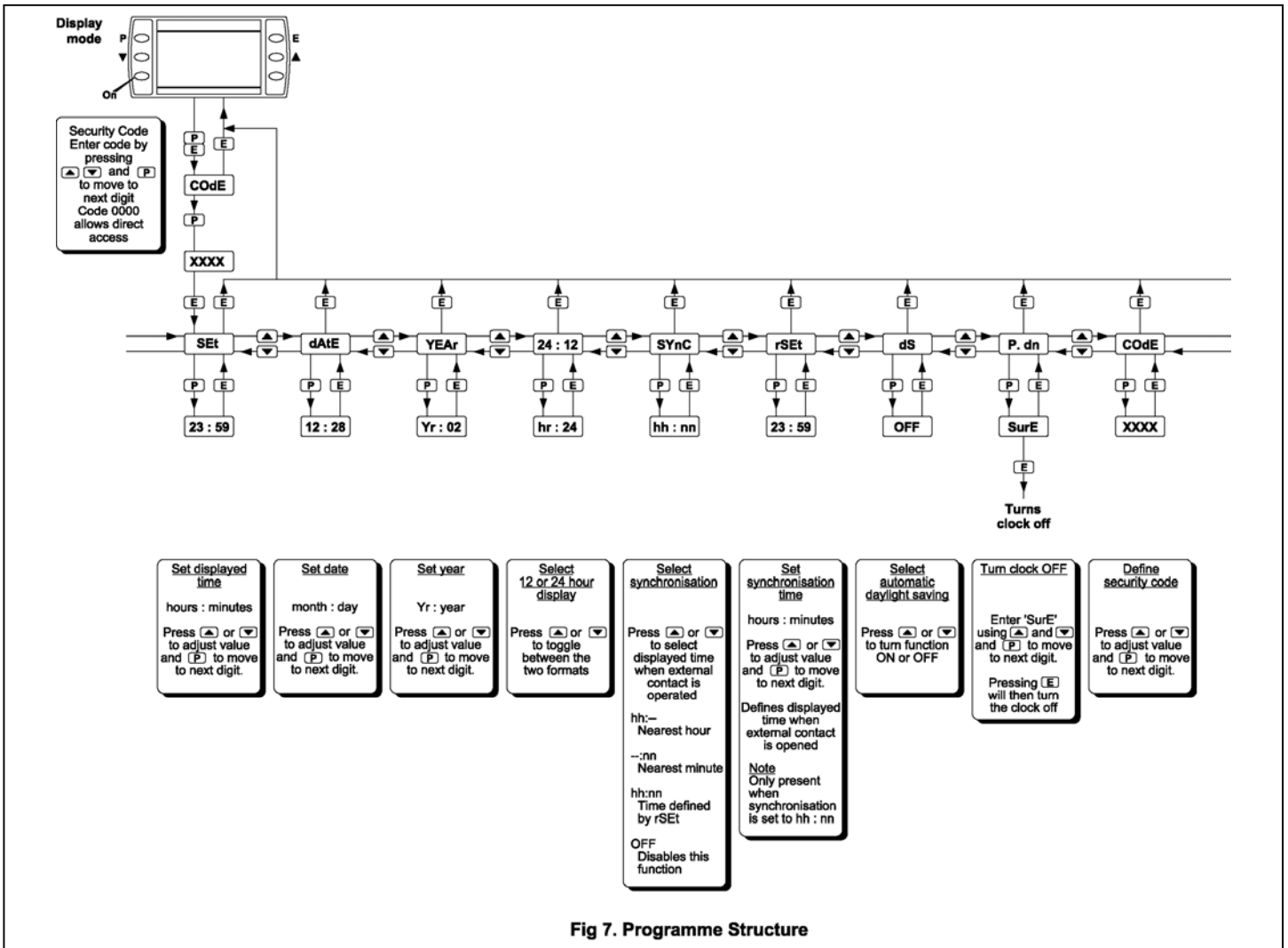

#### 4.2 Set displayed time: 'SEt'

This function enables the clock display time to be set. Using the *Up* or *Down* button select the 'SEt' function from the programme menu and press *P*. This will reveal the current clock time with one digit flashing. The flashing digit can be adjusted using the *Up* and *Down* buttons, pressing *P* will transfer control to the next digit. When the displayed time is set as required, press *E* to start the clock and return to the programme menu.

**Note:** SEt time is always entered in 24 hour format.

#### 4.3 Set date: 'dAtE'

The date is entered in day : month format i.e. 11<sup>th</sup> December is entered as '11:12'. Select 'dAtE' from the programme menu and press *P* which will show the current setting with one digit flashing. The flashing digit can be adjusted using the *Up* and *Down* buttons and the *P* button to transfer control to the next digit. When the current date has been entered press *E* to return to the programme menu.

#### 4.4 Set year: 'YEAr'

The year is entered as two digits i.e. 2002 is entered as '02'. Select 'YEAr' from the programme menu and press *P* which will show the current setting with one digit flashing. The flashing digit can be adjusted using the *Up* and *Down* buttons, pressing the *P* button will transfer control to the other digit. When the current year has been entered press *E* to return to the programme menu.

#### 4.5 Select 12 or 24 hour display: '24:12'

A 12 or 24 hour display format may be selected. Using the *Up* and *Down* button select the '24:12' function from the programme menu and press the *P* button. This will reveal the current format which may be changed by operating the *Up* or *Down* button. When set as required press *E* to return to the programme menu.

#### 4.6 Select synchronisation: 'SYnC'

Connecting the synchronising terminals together will stop the clock. When the terminals are disconnected the clock will restart from one of three new times defined by this function. This function also enables the synchronising terminals to be disabled.

Restarting from the nearest minute or the nearest hour to the original displayed time allows a small correction to be made to compensate for running errors. Restarting the clock from the reset time defined by the rSEt function is useful when displaying elapsed time.

To check or change the synchronisation select 'SYnC' from the programme menu and press *P* which will show the current setting. Pressing the *Up* or *Down* buttons will scroll through the four options:

- hh : -- Display changes to the nearest hour
- : nn Display changes to the nearest minute
- hh : nn Display changes to the 'rSEt' time – see 4.7
- OFF Synchronisation terminals are disabled. When the required option is displayed, press *E* to return to the programme menu.

#### 4.7 Set synchronisation time: 'rSEt'

This function defines the time to which the display is set when 'hh:nn' is selected in the 'SYnC' function. – see 4.6

Using the *Up* and *Down* buttons select the 'rSEt' function from the programme menu and press the *P* button. This will reveal the synchronisation time with one digit flashing. The flashing digit can be adjusted using the *Up* and *Down* buttons, pressing the *P* button will transfer control to the next digit. When the synchronisation time is set as required press *E* to return to the programme menu.

**Note:** rSEt time is always entered in 24 hour format.

#### 4.8 Select automatic daylight saving: 'dS'

Daylight saving automatically advances the displayed time by one hour on the EEU agreed date in March and retards it by one hour in October. Using the *Up* and *Down* button select the 'dS' function from the programme menu and press *P*. This will reveal if daylight saving is 'On' or 'OFF'. Operating the *Up* or *Down* button will toggle between the two options. When set as required press *E* to return to the programme menu.

#### 4.9 Turn clock off: 'P.dn'

To extend battery life the clock may be switched off when not in use. All settings apart from the time and date will be stored in permanent memory. Select 'P.dn' from the programme menu and press *P* which will result in a '0000' prompt with the first digit flashing. To confirm the instruction enter the password 'SurE' using the *Up* and *Down* button to set each digit and the *P* button to transfer control to the next digit. *S* is entered as 5. When 'SurE' is displayed, pressing *E* will turn the clock off.

#### 4.10 Define security code: COdE

Access to the programme menu may be protected by a user selectable four digit numeric security code. New clocks are programmed with the default security code 0000 which allows unrestricted access without entering a code.

To enter a new security code select 'COdE' from the menu and press *P* which will result in the existing security code being displayed with one digit flashing. Each digit can be changed using the *Up* and *Down* buttons and the *P* button to move to the next digit. When the required code has been entered, press *E* to return to the programme menu. The revised security code will be activated when the clock is returned to the display mode.

If the security code is lost, access to the programme menu can be obtained by moving the internal security link to the override position as shown in Fig 8. Access to this link is obtained by removing the clock rear panel as shown in Fig 9. The security code can then be viewed by selecting 'CodE' from the programme menu and pressing *P*.

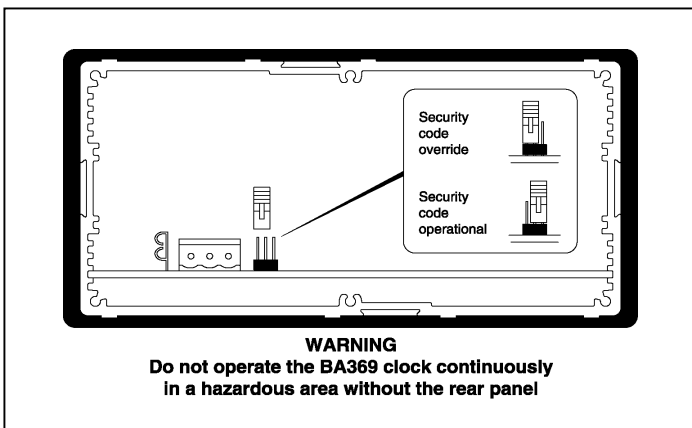

Fig 8 Location of security override link

## 5. ACCESSORIES

### 5.1 Tag number

The BA369 clock can be supplied identified by a tag number thermally printed on a self adhesive label.

## 6. MAINTENANCE

The clock should be regularly inspected to ensure that it has not been damaged. Frequency of inspections depends upon environmental conditions, but initially we recommend that this should be done annually.

### WARNING

**No attempt should be made to repair a faulty BA369 clock. Suspect clocks must be returned to BEKA associates or to your local agent for repair.**

### 6.1 Installing a replacement battery

The internal intrinsically safe battery will power the BA369 clock continuously for at least two years, when the battery requires replacing the display digits will flash, after which the clock will continue to operate for about five hundred hours before automatically switching off.

BA491 replacement battery units are available from BEKA associates and our agents. At 20°C replacement batteries only lose about one percent of their charge each year, so it is practical to stock a spare on-site but they

must be conditioned before installation in the BA369 clock otherwise the clock may not start. See instructions supplied with BA491 battery.

### WARNING

**To maintain the BA369 ATEX certification only a BEKA BA491 component certified battery should be installed in the clock. No attempt should be made to recharge or to open the battery assembly**

The discharged battery may be removed and the replacement fitted while the BA369 clock is installed in the hazardous area. Fig 9 illustrates the replacement sequence.

- Remove the synchronising terminals from rear of the clock by gently pulling.
- Remove the six screws securing the rear panel and lift it off.
- Gently pull out the horizontal printed circuit board.
- Remove the two screws securing the BA491 battery and un-plug the assembly.
- Condition the new BA491 battery as described in the instructions supplied with the battery.** Install the new battery in the clock and replace the printed circuit board enclosure, ensuring that connectors are correctly aligned. Refit the rear panel and synchronising terminals.
- Finally turn the clock on as described in 3.2 (e) and set the displayed time and date. All other parameters will remain unchanged

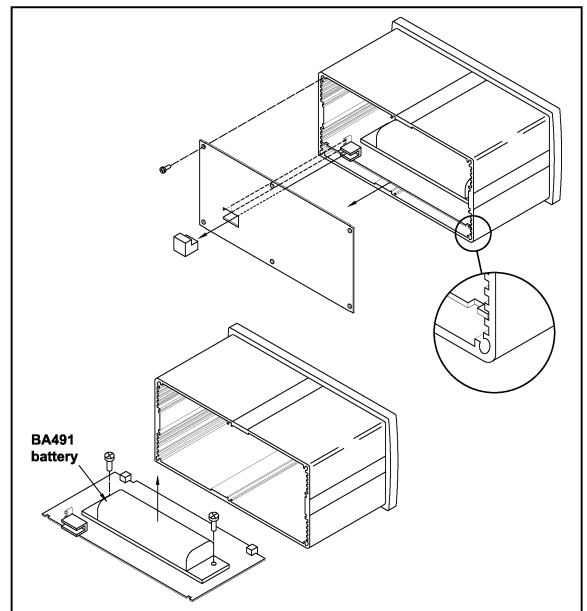

Fig 9 Replacement of internal battery

### 6.2 Disposal of used batteries

The BEKA BA491 battery contains Lithium Thionyl Chloride cells which should not be included with standard industrial waste. Do not incinerate. More information on disposal is available from The British Battery Manufacturers Association [www.rebat.com](http://www.rebat.com)

## 7. GUARANTEE

Clocks which fail within the guarantee period should be returned to BEKA associates or our local agent. It is helpful if a brief description of the fault symptoms is provided.

## 8. CUSTOMER COMMENTS

BEKA associates are always pleased to receive comments from customers about our products and services. All communications are acknowledged and whenever possible, suggestions are implemented.

**Issue 5 9<sup>th</sup> December 2011**